

# VoiceLive

Harmony | Correction | Effects



USER'S MANUAL



# IMPORTANT SAFETY INSTRUCTIONS



The lightning flash with an arrowhead symbol within an equilateral triangle, is intended to alert the user to the presence of uninsulated "dangerous voltage" within the product's enclosure that may be of sufficient magnitude to constitute a risk of electric shock to persons.



The exclamation point within an equilateral triangle is intended to alert the user to the presence of important operating and maintenance (servicing) instructions in the literature accompanying the product.

- 1 Read these instructions.
- 2 Keep these instructions.
- 3 Heed all warnings.
- 4 Follow all instructions.
- 5 Do not use this apparatus near water.
- 6 Clean only with dry cloth.
- 7 Do not block any ventilation openings. Install in accordance with the manufacturer's instructions.
- 8 Do not install near any heat sources such as radiators, heat registers, stoves, or other apparatus (including amplifiers) that produce heat.
- 9 Do not defeat the safety purpose of the polarized or grounding-type plug. A polarized plug has two blades with one wider than the other. A grounding type plug has two blades and a third grounding prong. The wide blade or the third prong are provided for your safety. If the provided plug does not fit into your outlet, consult an electrician for replacement of the obsolete outlet.
- 10 Protect the power cord from being walked on or pinched particularly at plugs, convenience receptacles, and the point where they exit from the apparatus.
- 11 Only use attachments/accessories specified by the manufacturer.
- 12  Use only with the cart, stand, tripod, bracket, or table specified by the manufacturer, or sold with the apparatus. When a cart is used, use caution when moving the cart/apparatus combination to avoid injury from tip-over.
- 13 Unplug this apparatus during lightning storms or when unused for long periods of time.
- 14 Refer all servicing to qualified service personnel. Servicing is required when the apparatus has been damaged in any way, such as power-supply cord or plug is damaged, liquid has been spilled or objects have fallen into the apparatus, the apparatus has been exposed to rain or moisture, does not operate normally, or has been dropped.

## Warning!

- To reduce the risk of fire or electrical shock, do not expose this equipment to dripping or splashing and ensure that no objects filled with liquids, such as vases, are placed on the equipment.
- This apparatus must be earthed.
- Use a three wire grounding type line cord like the one supplied with the product.
- Be advised that different operating voltages require the use of different types of line cord and attachment plugs.
- Check the voltage in your area and use the correct type. See table below:

| Voltage  | Line plug according to standard   |
|----------|---|
| 110-125V | UL817 and CSA C22.2 no 42.  |
| 220-230V | CEE 7 page VII, SR section 107-2-D1/IEC 83 page C4.   |
| 240V     | BS 1363 of 1984.<br>Specification for 13A fused plugs and switched and unswitched socket outlets. |

- This equipment should be installed near the socket outlet and disconnection of the device should be easily accessible.
- To completely disconnect from AC mains, disconnect the power supply cord from the AC receptable.
- The mains plug of the power supply shall remain readily operable.
- Do not install in a confined space.
- Do not open the unit - risk of electric shock inside.

## Caution:

You are cautioned that any change or modifications not expressly approved in this manual could void your authority to operate this equipment.

## Service

- There are no user-serviceable parts inside.
- All service must be performed by qualified personnel.

# IMPORTANT SAFETY INSTRUCTIONS

## EMC / EMI.

This equipment has been tested and found to comply with the limits for a Class B Digital device, pursuant to part 15 of the FCC rules. These limits are designed to provide reasonable protection against harmful interference in residential installations. This equipment generates, uses and can radiate radio frequency energy and, if not installed and used in accordance with the instructions, may cause harmful interference to radio communications. However, there is no guarantee that interference will not occur in a particular installation. If this equipment does cause harmful interference to radio or television reception, which can be determined by turning the equipment off and on. The user is encouraged to try to correct the interference by one or more of the following measures:

- Reorient or relocate the receiving antenna.
- Increase the separation between the equipment and receiver.
- Connect the equipment into an outlet on a circuit different from that to which the receiver is connected.
- Consult the dealer or an experienced radio/TV technician for help.

## For the customers in Canada:

This Class B digital apparatus complies with Canadian ICES-003.  
Cet appareil numérique de la classe B est conforme à la norme NMB-003 du Canada.

## Certificate Of Conformity

TC Electronic A/S, Sindalsvej 34, 8240 Risskov, Denmark, hereby declares on own responsibility that following products:

### **VoiceLive - Harmony, Correction and Effects Processor**

- that is covered by this certificate and marked with CE-label conforms with following standards:

- |                      |   |
|----------------------|---|
| EN 60065 (IEC 60065) | Safety requirements for mains operated electronic and related apparatus for household and similar general use                               |
| EN 55103-1           | Product family standard for audio, video, audio-visual and entertainment lighting control apparatus for professional use. Part 1: Emission. |
| EN 55103-2           | Product family standard for audio, video, audio-visual and entertainment lighting control apparatus for professional use. Part 2: Immunity. |

With reference to regulations in following directives:  
73/23/EEC, 89/336/EEC

Issued in Risskov, 03 - 2004  
Mads Peter Lübeck  
Chief Executive Officer

# TABLE OF CONTENTS

## INTRODUCTION

|                                    |   |
|------------------------------------|---|
| <i>Table of Contents</i> . . . . . | 3 |
| <i>Text Conventions</i> . . . . .  | 3 |
| <i>Introduction</i> . . . . .      | 5 |
| <i>Front Panel</i> . . . . .       | 6 |
| <i>Rear Panel</i> . . . . .        | 8 |
| <i>Signal Flow</i> . . . . .       | 9 |

## QUICKSTART

|   |
|---|
| <i>Getting Sound From the VoiceLive</i> . . .10 |
| <i>Step Through Orientation</i> . . . . .10     |
| <i>Preset Mode</i> . . . . .10                  |
| <i>Song Mode</i> . . . . .12                    |
| <i>User Button</i> . . . . .13                  |
| <i>Expression Pedal</i> . . . . .13             |
| <i>Making Scale Harmony Presets</i>             |
| <i>Work With Your Song</i> . . . . .14          |
| <i>Basic Editing Concepts</i> . . . . .15       |

## BASIC OPERATION

|  |
|--|
| <i>Live Setup with Guitar</i> . . . . .16    |
| <i>Live Setup with a MIDI Keyboard</i> . .16 |

## BASIC OPERATION

|   |
|---|
| <i>Parameter Types</i> . . . . .17              |
| <i>Preset Types</i> . . . . .17                 |
| <i>MIDI Backup and Restore</i> . . . . .17      |
| <i>Global Effect Preset Setting</i> . . . . .17 |
| <i>Store Operation</i> . . . . .18              |

## PRESET MODE

|                                       |
|---------------------------------------|
| <i>Preset Mode</i> . . . . .19        |
| <i>Preset Direct Mode</i> . . . . .20 |
| <i>Preset Voice Mode</i> . . . . .20  |

## PRESET EDIT SCREENS

|   |
|---|
| <i>Configuration Screens</i> . . . . .21      |
| <i>Voice Edit Screens</i> . . . . .22         |
| <i>Harmony Edit Screens</i> . . . . .26       |
| <i>Thicken Edit Screen</i> . . . . .28        |
| <i>Effects Edit Screens</i> . . . . .30       |
| <i>Pitch Correct Edit Screens</i> . . . . .33 |
| <i>Special Edit Screens</i> . . . . .35       |

## GLOBAL EDIT SCREENS

|   |
|---|
| <i>IO Edit Screens</i> . . . . .37      |
| <i>Utility Edit Screens</i> . . . . .40 |

## SONG MODE

|  |
|--|
| <i>Song Mode</i> . . . . .45                 |
| <i>Song Mode LCD Screen</i> . . . . .45      |
| <i>Song Edit Mode LCD Screen</i> . . . . .45 |
| <i>Song Edit Functions</i> . . . . .46       |

## HARMONY AND TUNING

|   |
|---|
| <i>Harmony</i> . . . . .48                |
| <i>Harmony Hold</i> . . . . .48           |
| <i>Harmony Modes</i> . . . . .48          |
| <i>Notes Mode</i> . . . . .48             |
| <i>Shift Mode</i> . . . . .48             |
| <i>Chord (Chordal) Mode</i> . . . . .48   |
| <i>Scale (Scalic) Mode</i> . . . . .49    |
| <i>Diatonic and Chromatic</i> . . . . .50 |
| <i>Just Tuning</i> . . . . .51            |

## FOOTSWITCH FUNCTION TABLES

|   |
|---|
| <i>Preset Mode Footswitch Functions</i> . .52 |
| <i>Song Mode Footswitch Functions</i> . .53   |

## SPECIFICATIONS

|   |
|---|
| <i>MIDI Implementation</i> . . . . .54      |
| <i>Technical Specifications</i> . . . . .57 |

## TEXT CONVENTIONS

Throughout this manual the following conventions will be followed:

- Names of front panel controls, and keys are written in **CAPITALS**.
- Parameter names are in SMALL CAPITALS.
- Parameter values are in underline.
- Special notes appear in *italic*.



# INTRODUCTION

Thank you for purchasing VoiceLive, TC-Helicon's harmony, correction and effects processor built for the road. A lot of effort went into this product. TC-Helicon engineers and product specialists met with performing musicians to make sure VoiceLive enhances your vocals on stage. The analog and digital signal path is designed to the same standards as our studio processors. However, every aspect of VoiceLive, from VOS™ limiting to the instrument input, has been designed for the specific demands of live performance. We hope you and your fans enjoy VoiceLive.

We update our manuals and various support material on a regular basis. For the most up to date information we encourage you to visit our website at [www.tc-helicon.com](http://www.tc-helicon.com)

## Features:

- Studio-quality mic preamp (Burr Brown INA163 based) with VOS™ Limiter and 48V phantom power
- Vocal processing technology based on VoiceWorks including:
  - The most natural sounding vocal harmony available using proprietary TC-Helicon technology
    - HybridShift™ harmony generation for smooth, natural harmony voices
    - Humanization of harmony voices utilizing FlexTime™, Human-Modeled Vibrato, Inflection, Pitch randomization, Portamento and gender
    - Four harmony control modes for intelligent voicing and/or MIDI control
    - Selectable Equal-tempered and Just tuning for harmonies
    - HarmonyHold™ - freezes harmony voices for more interesting harmony phrasing.
  - Automatic pitch correction using factory and custom scales
  - Lead voice thickening
  - TC Electronic 3-band EQ, low cut and compressor/gate
  - TC Electronic reverb & tap-tempo delay
- Eight smooth-travel footswitches
- Four edit knobs and one encoder for hands-on preset editing
- Expression pedal input
- MIDI control over all parameters via CC and SYSEX
- MIC pass-thru for post mixing by Front of House engineer
- Instrument input to reverb/delay
- 24 bit harmony processing
- S/PDIF digital I/O

Please refer to this manual often, as there are many features and variations to explore. Our website is another good resource for applications, support and other user services.

Enjoy!

The TC-Helicon Team  
[www.tc-helicon.com](http://www.tc-helicon.com)

# FRONT PANEL

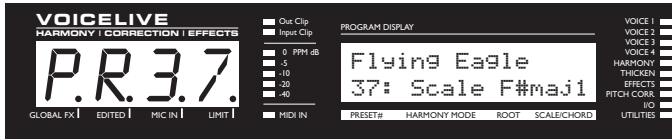

## LED TEXT DISPLAY

Displays important, top-level performance and editing information.

## GLOBAL FX DOT

Indicates that a global effect preset has been selected. This means that delay and reverb settings will remain unchanged when changing presets.

## EDITED DOT

Indicates that preset settings have been edited. Powering down or changing to another preset without first storing will result in a loss of changes.

## MIC IN DOT

Indicates that the microphone input is selected.

## LIMIT DOT

Indicates that the limiter is active.

## INPUT METER

Peak meter shows Mic or Line Input level. The meter range is: -40 to 0dB.

## INPUT CLIP LED

Indicates that the Mic/Line or instrument input level is too high, possibly causing digital distortion. Reduce the input level to correct this condition. The Input Clip LED may flash when the limiter is enabled, which indicates clipping of initial transients and does not severely degrade audio performance.

## OUTPUT CLIP LED

Indicates an internal DSP overflow. Reduce the overall level of the harmony voices and vocal effects to correct this condition.

## MIDI IN LED

Indicates valid, incoming MIDI information.

## LCD TEXT DISPLAY

Displays top-level preset information (**preset mode**), detailed preset information (**preset edit screens**), system configuration (**I/O and utility edit screens**), Song data (**Song mode**), and any important status messages or user alerts.

## Voices LEDs (1-4)

Indicates On/Off status of individual harmony voices. All 4 green LEDs flash to indicate Harmony Mute as a result of the HARMONY MUTE/HOLD FOR BYPASS button pressed.

## Red Voice Effect LEDs

These indicate the effects that are enabled for a preset. All 4 red LEDs flash to indicate that Voicelive is in Bypass mode as a result of holding the HARMONY MUTE/HOLD FOR BYPASS button.

## HARMONY LED

Indicates On/Off status of overall harmony.

## THICKEN LED

Indicates On/Off status of lead voice thickening.

## EFFECTS LED

Indicates On/Off status of Reverb and Delay.

## PITCH CORRECT LED

Indicates On/Off status of pitch correction.

## I/O LED

Indicates that you are on an I/O parameter edit screen.

## UTILITIES LED

Indicates that you are on a Utility parameter edit screen.

## LEVEL/EDIT KNOBS

In performance modes, these are used to adjust audio levels of **Lead Voice**, **Harmony Voices**, **Instrument** input and overall **Output level**. *You store the I/O/UTIL settings to save these level settings. Press STORE to initiate this procedure.* In the edit modes, these knobs are used to adjust parameter values. Please note that at the end of the travel of these knobs, the parameter values will scroll. Turn back the knob to stop scrolling and adjust to find your desired value.

# FRONT PANEL

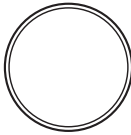

PUSH TO ENTER

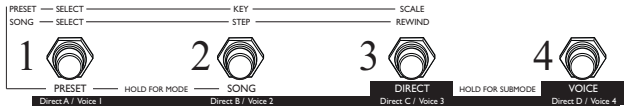

## EDIT KEY

Enters and exits **edit modes**.

## STORE KEY

Press STORE to begin the store process. Presets, Songs and IO/Utility parameters may be stored using this key. Each Preset and Song name/number store destination may be changed after the first press. Pressing the STORE key a second time will complete the store operation.

## DATA WHEEL

This control is used to select presets in preset mode, songs in Song mode and edit screens in edit mode. With the Store Operation this is used to select whether to store Preset, Song or IO/Util parameters. Parameters surrounded by triangular brackets (eg. <STEP INS> ) may be changed using the DATA WHEEL.

## PUSH WHEEL TO ENTER

Pressing the DATA WHEEL activates special functions in the **Preset edit** and **Song edit** modes. Parameters surrounded by triangular brackets (eg. <Execute> MIDI-Dump) perform their actions when ENTER is pressed.

## FOOTSWITCH BUTTONS

These allow control of VoiceLive in performance. These buttons are multifunctional depending on the operating mode of the unit.

The best place to get an understanding of how these work is the *Performance Mode Step Through Orientation* in the *Quickstart* section of the manual. For a detailed reference of the operation of the footswitches in the various modes, see the *Footswitch Function Tables* near the end of the manual.

**Please note that the footswitch buttons have multiple functions. To ensure clarity in this manual they will often be referred to as switches 1 through 8 as numbered above.**

# REAR PANEL

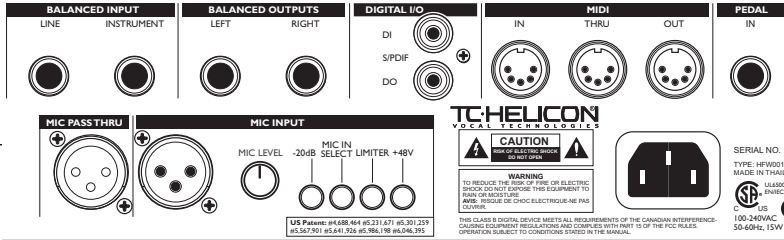

## Balanced Inputs (1/4" TRS)

**Line** - You have the option of selecting this or the mic input as the main Vocal input.

**Instrument** - This input is designed to accept output from the following sources:

- Mixer
- Guitar pedal or preamp
- Active pickups (guitar with batteries)
- Acoustic guitar with preamp
- Keyboard output

Plugging an electric or acoustic guitar with passive pickups directly into this input will not result in optimal audio quality. (See note on page 16.)

## Balanced Outputs (1/4" TRS)

**Left/Right** - This is the stereo output of VoiceLive. If mono operation is desired use either of the outputs and set the **OUTPUT** parameter to Mono (edit screen 109). These outputs may be connected directly to balanced mic inputs with proper 1/4" TRS to XLR out adapters as long as *there is no phantom power on the input*. It is also necessary to set the **OUTPUT RANGE** to a lower setting (edit screen 109) when driving mic inputs. When there is phantom power, direct boxes are necessary to connect to mic inputs.

## Digital I/O

**S/PDIF In/Out** - Sends and receives digital audio to S/PDIF standards.

## MIDI

**In, Out and Thru** - Standard MIDI interface

## Pedal In

Accepts passive volume pedals and expression pedals. The operation of the

expression pedal can be programmed per preset on edit screen *XPED* and globally on edit screen *UT1*.

## Mic Pass Thru

This connects directly to the microphone input and is used to connect directly to a mixing board. If VoiceLive loses power for any reason, the signal from the microphone will still get through to the mixer. When using this connector and microphones requiring phantom power, you have the option of using the phantom power from VoiceLive or the mixing console. *Please note that using both the mixing console phantom power through this connector and VoiceLive phantom power will result in too much power to the microphone.*

## Mic Input

**Mic Connector** - Balanced microphone input.

**MIC LEVEL Knob** - This controls the input gain of the mic input.

**-20dB** - This attenuates the input by 20dB to handle high output condenser microphones (and the occasional really loud singers with dynamic microphones).

**MIC IN SELECT Button** - This selects the microphone for the Vocal input. When not pressed, VoiceLive defaults to the Line input.

**LIMITER Button** - This enables the VOS™ optical limiter on the mic input.

**+48V** - This enables +48 V phantom power on the mic input. *Never plug single ended (unbalanced) microphones or instruments or signal processors (balanced or unbalanced) into the mic input if +48V phantom power is on.*

**Note:** Optimal connection to balanced equipment is achieved using balanced cables. However, if your equipment is NOT balanced you will generally have no problems.

# SIGNAL FLOW

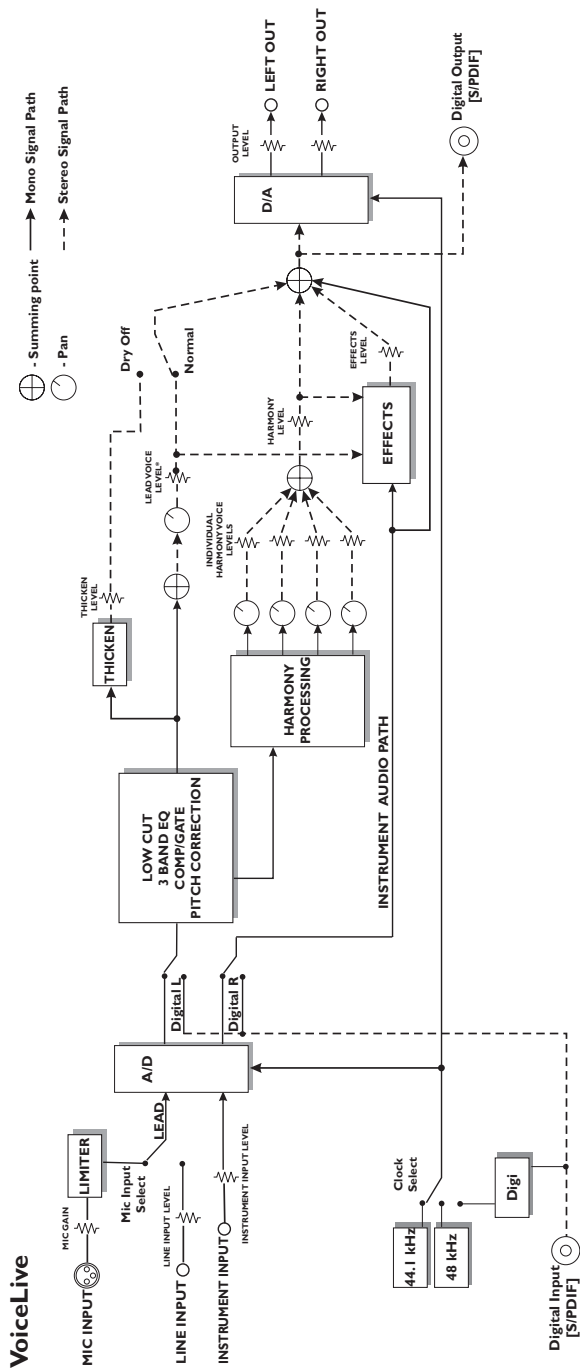

# QUICKSTART

## Getting Sound From VoiceLive

What you Need:

- VoiceLive
- Power cable
- microphone
- microphone cable
- two 1/4" cables
- PA or powered speakers

1. Connect the power cable to VoiceLive and to your mains power. VoiceLive does not have a power switch so just plugging it in will turn it on.
2. Connect the two 1/4" cables to the Left and Right output of VoiceLive into two inputs on your PA or powered speakers.
3. With the MIC LEVEL knob and the OUTPUT knob at minimum (fully counter-clockwise) connect one end of your microphone cable to your microphone. Plug the other end into the MIC input of VoiceLive.
4. Engage the 'microphone' and 'limiter' switches on the back panel (the limiter switch will make it easier to set the levels). If your microphone requires phantom power engage the 'phantom power' switch on the back panel.
5. While singing into the microphone increase the microphone volume using the MIC IN knob until the level meters on the display are fluctuating above '-20dB' but never to the 'red' with clipping. If the level from the microphone is always too high, engage the '-20dB Pad' switch on the back panel.

7. With your PA or speaker level at a nominal setting sing through the microphone adjusting the 'Lead', 'Harmony', 'Effects' and 'Output' level using the edit knobs on the front panel.
8. Push on the PREVIOUS/NEXT buttons (5,6) or turn the DATA WHEEL to try out the different presets.

## VoiceLive Performance Features

VoiceLive is designed to be the ultimate vocal performance product. Foot control of vocal effects and harmonies can be achieved at various levels. On a basic level in preset mode, you can scroll through presets. On an advanced level in Song mode you can arrange preset sequences with markers within the sequence. Along with this sophistication of preset access, is the preset-assignable USER button and EXPRESSION pedal control.

### Step Through Orientation

Most of this orientation may be done with the footswitch buttons. Plug in a microphone and put it on a stand to free up your hands to hold this manual. Try going through this procedure, singing into the microphone as you go and jamming with VoiceLive. Often during this orientation we give background to how certain things are set up. *This often means referring to "edit screens". These edit screens can be accessed by pressing the EDIT button and turning the DATA WHEEL.*

### Preset Mode

This is VoiceLive's basic performance mode. On power-up VoiceLive is in Preset Mode.

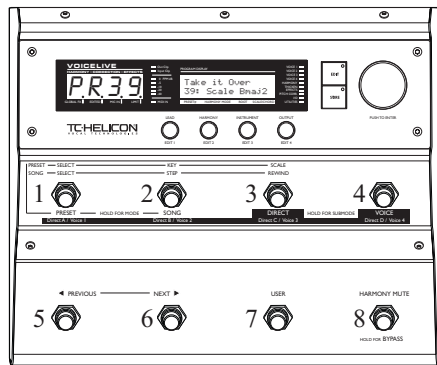

- Press the PREVIOUS/NEXT buttons (5, 6 shown above) to change the preset number.
- Select preset Number 11 which is a Scale type preset.

# QUICKSTART

- Press the USER Button. You will now hear the "Telephone Voice" effect. This preset has the USER button setup to do this function. (make sure you try singing into the mic to hear what's going on)
- Press the HARMONY MUTE button (8) to turn off the harmonies.
- Press the USER button and then the HARMONY MUTE button to enable the harmonies and disable the Telephone Voice effect.
- Hold the HOLD FOR BYPASS BUTTON (8) to bypass all effects on VoiceLive.
- Hold the HOLD FOR BYPASS BUTTON (8) again to enable effects in VoiceLive.
- Press the KEY button (2) followed by the PREVIOUS/NEXT buttons to change the key of the harmony scale.
- Press the SCALE button (3) followed by the PREVIOUS/NEXT buttons to change the scale type.
- Press the PRESET SELECT (1) button followed by the PREVIOUS/NEXT buttons to change the preset number.

*Note: Key and Scale may only be changed with scale type presets. Pressing the KEY (2) and SCALE buttons when on anything other than a Scale preset will have no effect.*

## Preset Direct Mode

Preset Direct Mode makes the top buttons on VoiceLive respond like radio station buttons on a car radio for preset access.

- Hold the DIRECT button (3) when in preset mode until the LED Text Display flashes *DIRECT*, putting VoiceLive into Preset Direct Mode.
- Press any of the top 4 buttons to access the programmed direct presets.
- Press the PREVIOUS/NEXT buttons to find a different preset that you like, making sure that the second character on the LED text display is a "\*".
- Press and hold one of the top 4 buttons, until the second character on the LED text display changes to A, B, C or D. You have now programmed that button to recall the desired preset.

*Note: Holding a direct button when a preset has not been changed ("\*" is not displayed) will cause VoiceLive to leave direct mode.*

Here's how the LED text Display works in Preset Direct Mode:

For example: **PA23**

P: This character indicates that the unit is in Preset Mode.

A: A,B,C,D means that a Direct preset is recalled. Holding one of the top 4 buttons when this is displayed will put VoiceLive into a new mode. If this character is a "\*" then a Direct preset is not recalled. Holding one of the 4 top buttons will program this button to recall the current preset.

23: This indicates the current preset number.

- Find a preset that you like with lots of harmony using the PREVIOUS/NEXT buttons.
- Hold one of the top four buttons to program a DIRECT button to this preset.

## Preset Voice Mode

- Hold the VOICE button (4) until the LED text display flashes *VOIC* to put VoiceLive into Preset Voice Mode.
- Press any of the top four buttons to enable/disable a harmony voice. Notice that the Vocal 1 - 4 LEDs to the right of the LCD display indicate which Voices are enabled.
- Press the PREVIOUS/NEXT buttons to change presets. Notice that the enabled/disabled combination of voices do not change as you change presets.

Here's how the LED text Display works in Preset Voice Mode:

For example: **PV23**

P: This character indicates that the unit is in Preset Mode.

V: This indicates that VoiceLive is in Voice Mode.

23: This indicates the current preset number.

# QUICKSTART

## Song Mode

This is VoiceLive's advanced performance mode. Song mode allows you to:

1. Create sequences of presets that you can step through.
2. Modify the Scale Root and Type as well as Chord Root and Type of the presets within the Song steps.
3. Set up to 4 markers in each song with Direct Song mode.

Follow the steps below to learn the capabilities of Song Mode.

- Hold the SONG button (2) until the LED text display flashes *SONG* to enter Song mode.
- Press the PREVIOUS/NEXT buttons (5, 6) to change the Song number to Song 3, "Amazing Grace".
- Press the STEP button (2) to allow stepping through the song.
- Sing into your microphone. You'll hear chord based harmonies.
- Press the NEXT button (6) to advance the step of the song. Hear how the harmonies change.
- The Song Mode LCD screen looks like this:

```
3: AMAZING GRACE
S2 P39c G Dom7
```

Top Line- Song number and name

S2 - Step number.

P39c - Preset number and harmony type. s= Scale; c= Chord; n= notes; blank =shift.

G DOM7 - Root and Scale/Chord type for Scale and Chord presets.

- Press the NEXT button (6) a few times while watching the LCD display. Notice that the preset number does not change. All that changes between steps is the Root and chord type. This is how this song was programmed.
- Press the REWIND button (3) to rewind back to the first step.

## Editing Song Step Sequences

- Press the EDIT KEY to enter the Song Step edit mode.
- Turn EDIT 1 knob to select the step you would like to edit or turn to a new step.
- Turn EDIT 2 knob to change the preset number.
- Turn EDIT 3 knob to change the Chord/Scale root.
- Turn EDIT 4 knob to change the Chord/Scale type.
- Turn the DATA WHEEL to select Insert or Delete step functions.
- Once the desired function is selected, press the DATA WHEEL to enter.
- To save changes press the STORE KEY. You may then change the Song name and number
- Press the STORE KEY again to complete the store operation.
- Press the EDIT KEY to go back to the Song Step mode.

## Song Direct Mode

Song Direct mode is a powerful way to use VoiceLive. You can use it in a number of different ways.

2. Sequence the chords of the intro, Verse, chorus and bridge of a song into the steps of a Song. Go into Song Direct mode and assign the beginning of each section to the direct buttons.
  1. Put 4 presets with Root and Scale/chord types customized for your music in a song and have direct access to them. There are 50 songs in VoiceLive so in doing this you could effectively create 50 groups of presets for efficient live recall.
- Press the SONG SELECT button (1) to change the Song number.
  - Press the NEXT button (5) to advance to an empty song.
  - Press the STEP button (2).
  - Press the EDIT KEY to enter edit mode.
  - Turn EDIT 1 and EDIT 2 knobs to assign presets 62, 64, 68 and 69 to steps 1 - 4.

# QUICKSTART

- Press the EDIT KEY to exit edit mode.
- Hold the DIRECT button (3) to enter Song Direct mode.
- Press the NEXT button (5) to advance to Step 2
- Hold the DIRECT B button (2) to assign Step 2 to this button. *Please note that when new songs are created all direct buttons are assigned to Step 1.*
- Press the NEXT button (5) to advance to Step 3
- Hold the DIRECT C button (3) to assign Step 3 to this button.
- Press the NEXT button (5) to advance to Step 4
- Hold the DIRECT D button (4) to assign Step 4 to this button.
- Talk into the mic and press the different DIRECT buttons (DiRECT A to DiRECT D). Hear yourself take on different personalities.
- To store the Song to the current location, press the STORE key, edit the Song name using EDIT knobs 1 and 2 and press STORE again.

## Song Voice Mode

Song Voice mode makes it possible to toggle each individual harmony voice on/off. This is useful for building up voices during a chorus.

- Hold the VOICE button (4) until the LED text display flashes *VOIC* to enter the Voices Submode. *(Note that if you changed Song steps with the PREVIOUS/NEXT buttons (5, 6) prior to holding this button or any of the top four buttons, the second character on the LCD display will show “\*” and the current step would then be programmed to that DIRECT button. The second character on the LED display must read A, B, C or D to allow changing to another mode).*
- Press any of the upper 4 buttons to turn on and off individual voices.
- Press the PREVIOUS/NEXT buttons (5, 6) to change the Song step. Note that the enabled/disabled combinations of voices do not change while changing steps. This is really handy when you want to increase the number of harmony voices for a later part of a song.

## USER Button

In every preset you have the option of either assigning a unique function to the USER button or setting the USER button to Default (edit screen *UBTN*). When set to Default the USER button is assigned to the setting in the global edit screen *UT2*. Most factory presets in VoiceLive have the USER button set to default unless the USER button is integral to the preset. If you like to sustain your harmonies, then you may want to set the default USER button to Harmony Hold. If you perform songs where there are short phrases of harmonies, rather than having to press the HARMONY MUTE button at the start and at the end of the phrases, you can set the default USER button to Momentary Harmony. In cases where you have a harmony preset that works for a song but the intro requires a Low-Fi telephone sound, you may want to edit the preset and set the USER button (edit screen *UBTN*) to TeleVoice All so that regardless of the default USER button setting, in that preset, pressing the USER button creates a Low-Fi effect.

## EXPRESSION Pedal

In the same way as the USER button, you have the option of assigning a unique function to the Expression Pedal or setting it to default in the preset (edit screen *XPED*). Most factory presets in VoiceLive come with the Expression Pedal set to Default. In the *UT1* edit screen you may want to set this default to Harm Lev Narrow so that you can control the harmony levels with your foot.

You must calibrate the EXPRESSION pedal for proper operation. See edit screen *UT9* for details.

The USER button and Expression pedal capabilities are extremely flexible and powerful, allowing you to set VoiceLive for optimal control and creative possibilities.

## Making Scale Harmony Presets Work with Your Song

When you're not using MIDI, **Scale Presets** are the best way to produce harmonies in VoiceLive. You need to know a few things to make this work:

1. In what key is the song (A,B C.. etc.)?
2. Is the song in a major or minor key?

Another thing you need is an instrument to sing with so that you know that you are singing in the right key.

- Hold the PRESET button (1) to put VoiceLive into preset mode.
- While singing "ahhh" into VoiceLive, find a preset with the word "Scale" in the second line having only one or two VOCAL LEDs lit. Choose one that has a general sound to the harmonies that you would like for the song.
- Press the KEY button (2) followed by the NEXT button to set the key of the Song.
- Press the SCALE button (3) followed by the NEXT button (6) to set the scale type of the song to either "M1" if the song is in a major key or "m1" if the song is in a minor key.
- Play a chord or a starting note on your instrument to ensure that you are going to sing in the right key, and try singing the song into VoiceLive.
- If the harmonies don't sound right try a different Scale type number (1, 2 or 3) by pressing the PREVIOUS/NEXT buttons (5,6). Remember to stick with "M" if your song is in a major key and "m" if your song is in a minor key.
- If they still don't sound right, press the KEY button (2) followed by the PREVIOUS button (5) *five times* to set the key to a 5th above the key of the song.
- If they still don't sound right press the SCALE button (3) followed by the PREVIOUS/NEXT buttons (5,6) to select a different scale type.

- Finally, if they still don't sound right press the KEY button (2) followed by the PREVIOUS button (5) two times to set the key to a 4th above the key of the song then try changing the scale.
- If one of the Key/Scale type combinations you tried above sounded close but not quite right, go back and set the Key and Scale to the best setting you achieved.

Up to this point we have been trying to find a key and scale type with a scale preset to work with the song. If there are only one or two notes in the song that don't sound right with the current setting, it may be possible to "adjust" the harmonies for those notes using a custom pitch map.

- Sing the song into VoiceLive and stop on the note that has the wrong harmonies.
- Figure out what note it is using your ears and your instrument or look at sheet music of the song.
- Press the EDIT key and turn the DATA WHEEL to edit screen 007.
- Press ENTER (the DATA WHEEL) and turn the DATA WHEEL until the In: note is the note with the wrong sounding harmonies.
- Adjust the voices to the correct notes using the 4 EDIT knobs. (you only have to adjust the voices that are shown lit on the LEDs)
- Try singing the song again to see if you need to adjust any more harmony voices and correct them using the procedure above.
- Press ENTER to allow normal operation of the DATA WHEEL.

If this still does not result in acceptable harmonies it may be because in the song you need to have different harmonies for the same note, depending on what the chord is. You then need to use chord presets in Song mode to step through the changing chord information in the song.

## Basic Editing Concepts

We have designed the factory presets in VoiceLive to be useful in many musical situations, but we know you will want to make your own presets that suit your taste and your needs. If you follow this tour you will quickly learn the basics of editing VoiceLive presets.

### Turning the voices and effects on and off within a preset and exploring their editable parameters

1. Hold the PRESET button (1) to enter preset mode.
2. Go back to Preset 1 using either the DATA WHEEL or the PREVIOUS/NEXT buttons (5,6).
2. Notice that each of the eight VOICES & EFFECTS LEDs is lit on the front panel. When the LED is lit, the voice or effect described by the LED is on.
3. Press the EDIT KEY and turn the DATA WHEEL until the LED TEXT DISPLAY reads *CFG2* (This is the second edit screen). To get to this screen you can turn the DATA WHEEL counter clockwise a couple of turns and then clockwise one click).
4. While singing, try turning off each of the four voices using the 4 EDIT knobs. Notice how the VOICE LEDs go off. Turn them back on.
5. Turn the DATA WHEEL counterclockwise one click to get to the CFG1 edit screen, then turn EDIT knob 1 to turn the HARM (harmony) parameter off. Notice that the Harmony LED goes off.
6. With harmonies off, now turn off the THICKEN, EFFECTS and PITCH CORRECT using the EDIT knobs 2-4. You will now only hear your singing voice. Turn them all back on.
7. Turn the DATA WHEEL to see what you can control and edit. Each edit screen has up to 4 parameters that may be edited using the 4 EDIT knobs. The IO and Utilities LEDs indicate that you are on pages that are Global and are not stored in the preset.
8. To save a preset at this point:
  - Press the STORE key
  - Select the "store to" location using EDIT 4 knob
  - Edit the preset name using EDIT knobs 1 and 2.
  - Press STORE again.
9. Press the EDIT key once to return to the top menu.
10. If you did not save the preset in step 8, pressing the PREVIOUS/NEXT buttons (5,6) or turning the DATA WHEEL will change the preset and to undo your edits.

# APPLICATIONS

## Live Setups

Using Voicelive is like bringing 4 professional backup singers to your gig! You've got several options when it comes to controlling Voicelive live. For best results you can use (in various combinations) the Express-1 expression pedal, a MIDI keyboard, a MIDI CC controller, and of course the controls on the box itself. We've provided setup examples below for a few common situations.

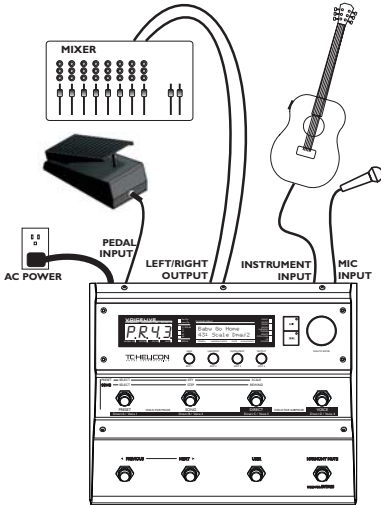

### Live Setup with Guitar

- Connect a microphone to the XLR mic input on Voicelive and enable the MIC input on the rear panel.
- Connect a guitar with a built-in pre-amp to the instrument input of Voicelive\*.
- Plug any passive volume or expression pedal into the Pedal Input of Voicelive. You must calibrate the expression pedal for proper operation. See edit screen *179* for details.
- Connect the Voicelive stereo output to a stereo channel (or two mono channels panned left and right) on your mixer. For **mono operation** use either of the Voicelive outputs and set the unit to mono operation with the OUTPUT parameter in the edit screen *109*.

### Live Setup with a MIDI Keyboard

- Connect a microphone to the XLR mic input on Voicelive and enable MIC input from the rear panel.
- Connect the keyboard mono output to the Voicelive Instrument Input.
- Connect the keyboard MIDI Output to the Voicelive MIDI input.
- Plug any passive volume or expression pedal into the Pedal Input of Voicelive. You must calibrate the expression pedal for proper operation. See edit screen *179* for details.
- Connect the Voicelive stereo outputs to a stereo channel (or two mono channels) on your mixer. For **mono operation** use either of the Voicelive outputs and set the unit to mono operation with the OUTPUT parameter in the edit screen *109*.

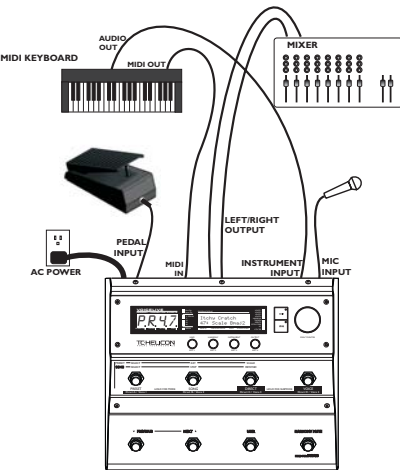

\* Note: For electric or acoustic guitars without a pre-amp, the use of an external preamp is necessary for optimal performance. Often, using a "stomp box" style effects pedal between the guitar and the Voicelive produces acceptable results. The output of the stomp box will be compatible with the instrument input of Voicelive. Make sure that the stomp box does not have a passive bypass. You can check this by removing the stomp box's battery- when you do you should not be able to get any sound out of it regardless of how many times you stomp on it.

# PRESET HANDLING

## Parameter types

VoiceLive has over 100 useful parameters and a user interface that lets you view and edit efficiently. There are *preset* parameters and *global* parameters. Pressing the EDIT key when in **preset mode** gets you into the **edit mode** where you can change these parameters.

**Preset** parameters are stored in each preset. In the **edit menu** The LED text display indicates the type of parameter. *CFG*-configuration, *VD*- individual voice, *HR*-harmony, *TH* - thickening, *FX*- effects, *CD*- pitch correction, *XPED* expression pedal and *UBTM* USER button are all preset parameter types. **Global** parameters do not change when a different preset is recalled. In the **preset edit menu** the I/O or UTIL LEDs are lit and the LED text Display shows *ID* or *UT* for global parameters. I/O and Util parameters include: Lead input level and pan, Compression/Gate, and EQ parameters among many others. If you change your microphone (or singer!) the EQ/Compression settings need be adjusted only once in the **edit menu**. If you wish to backup your setup settings, VoiceLive is able to MIDI dump setup parameters to sysex for later retrieval.

## Preset Types

It's important to understand the concept of the **current preset** versus **stored presets**.

The current preset is the preset that is always active in VoiceLive. Recalling a preset copies preset data from one of the 99 stored presets into the current preset. As you change the current preset, the underlying stored presets are not affected until you choose to store the current preset back to a stored preset.

When dumping and receiving presets via MIDI, data is dumped from and received to stored presets. The current preset remains untouched.

## MIDI Backup and Restore

VoiceLive allows MIDI dumping of all or individual presets, all or individual songs and VoiceLive global parameters.

- Connect the VoiceLive MIDI Out to MIDI In on either another VoiceLive or an external MIDI device.

- Enter the **edit menu** by pressing the EDIT key and scroll to the edit screen *UTB*.
- Turn EDIT 1 knob to select the MIDI-Dump function.
- Select what you would like to backup using the EDIT 2 knob. Pn indicates a preset; Sm indicates a song, and Setup indicates all global parameters.
- If connected to another VoiceLive simply press ENTER and your data will be copied to the other VoiceLive.
- If connected to a sequencer, arm it to record SYSEX data and press ENTER on VoiceLive.

It is possible to directly receive and dump from the current preset. Refer to the SYSEX MIDI documentation available on: [www.tc-helicon.com](http://www.tc-helicon.com).

All presets may be restored to their factory default from edit screen *UTB*.

## Global Effect Preset Setting

If you select a preset for the *GLBFX* parameter in the **edit menu** (edit screen *UT3*), its effect settings will be used regardless of the current preset effect settings. The Global FX LED DOT is lit when active.

If you store the current preset while a Global Effect is active, the current preset data will be stored to the selected preset number, but any changes to the effect data (which come from the Global preset) will be stored to the global preset.

All 99 presets shipped with VoiceLive can be modified or overwritten. You can always restore a preset to its factory default in the global edit screen *UTB*.

## VoiceLive is always ready to receive MIDI System Exclusive Dumps.

Simply connect MIDI Out from the device you are dumping from to the MIDI In on VoiceLive and send the SysEx dump at any time.

# STORE OPERATION

Pressing the STORE key on VoiceLive allows storing the current **Preset** or **Song**, or **IO and Util** Global System Parameters.



Above is an example of the store screen after editing a preset and pressing store. VoiceLive keeps track of the last thing you changed. Pressing the STORE button again will store the preset to the current location. For example, if the last thing you changed was a Global parameter under the IO and UTIL edit screens, the LCD display would show:

<IO/Util>

At this point the EDIT knobs and data wheel do the following:

**DATA WHEEL:** Selects whether to store current Preset, Song or IO/Util parameters.

When Preset or Song are selected by the DATA WHEEL:

**EDIT 1 knob:** Select character of preset/song name to edit

**EDIT 2 knob:** Change selected character.

**EDIT 4 knob:** Change Store destination.

Pressing store again will execute the store operation. To abort the store operation press the EDIT key. Storing after a quick edit is as simple as pressing the STORE button twice.

# PRESET MODE

Preset mode is VoiceLive's basic performance mode. Here you can select presets by turning the DATA WHEEL or by pressing the PREVIOUS/NEXT buttons. Direct and Voice modes give additional control.

To enter **Preset Mode**, hold the **PRESET** button (1) until the LED text display flashes **PRE**.

## Preset Mode LCD Screen

Go Your Own  
39: Scale F#maj2

The LCD display above is an example of a preset screen.

Here's what it all means.

- Top Line Preset Name
- 39 Preset number.
- Scale Harmony type of the current preset. This can be either Scale, Chord, Shift or Notes.
- F# Scale/Chord Root for scale and chord mode presets. Not applicable to Shift and Notes Presets.
- Maj2 Scale/Chord Type for scale and chord mode presets. Not applicable to Shift and Notes Presets.

## Preset Mode LED Displays

PR39

Above is an example of a Preset Select LED Display.

PR Indicates that you are in preset select mode.  
39 Preset number.

Pressing the PREVIOUS/NEXT buttons (5,6) will change the preset number.

F#m2

Above is an example of the Preset Scale Key Change and Preset Scale Type Change LED Displays.

When in Preset Mode you can get here either by pressing the KEY button (2) or SCALE button (3) when on a Scale type preset. This allows changing the scale key and type respectively with the PREVIOUS/NEXT buttons (5,6). Not applicable for other preset types.

F# Indicates the key of the scale of the current preset. # indicates a sharp (#).  
m2 Scale type. M indicates Major, m indicates minor. VoiceLive has 3 major scales, 3 minor scales and one custom scale type.

# PRESET MODE

## Preset Direct Mode

To enter **Preset Direct Mode**, you need to be in Preset Mode, then hold the **DIRECT** button (3) until the LED text display flashes **DRCT**.

**PA21**

Above is an example of a Preset Direct Mode Display

**P** This character means that you are in Preset Mode.

**A** This character means that you are in Direct Submode as well as:

- If it's an A,B, C or D then a Direct Preset has been recalled by pressing one of corresponding top four **DIRECT** buttons. In this case holding one of the top four buttons will change the mode of VoiceLive operation.
- If it's a "\*" then holding one of the top four buttons will program the current preset to the button held.

**21** This indicates the current preset number.

Pressing the **DIRECT** buttons (1-4) will jump to the direct programmed preset.

Holding the **DIRECT** buttons (1-4) will either program the current preset to that Direct Button (when the second LED character is a "\*\*") or change the mode of operation of VoiceLive.

**PREVIOUS/NEXT** buttons (5, 6) changes the preset. When this happens the second character on the LED display changes to a "\*\*", indicating that a **DIRECT** button may be programmed.

## Preset Voice Mode

To enter **Preset Voice Mode**, you need to first be in Preset Mode, then hold the **VOICE** button (4) until the LED text display flashes **VOIC**.

**PV21**

Above is an example of a Preset Voice Display.

**P** This character means that you are in Preset Mode.

**V** This character means that you are in Voice Submode.

**21** This indicates the current preset number.

Pressing the **VOICE** buttons (1-4) will enable/disable the individual harmony voices.

Holding the **VOICE** buttons (1-4) will change the mode of operation of VoiceLive.

Pressing the **PREVIOUS/NEXT** buttons (5, 6) changes the preset number. The enabled/disabled combinations of voices are maintained as presets are changed.

# PRESET EDIT SCREENS

Pressing the EDIT key while in Preset Mode gives access to the edit parameters. Turning the data wheel scrolls through the edit screens. Each edit screen has up to four parameters that may be adjusted with the EDIT knobs. This section of the manual goes screen by screen to describe the parameters in VoiceLive. To leave the edit screens press the EDIT key.

## Configuration Screens

The parameters in this section are used to enable/disable the harmony and effect components of a preset.



These parameters allow enabling/disabling of Harmony, Thickening, Effects and Pitch correction audio components. The **Voices and Effects LEDs** will reflect the settings of this page.

EDIT 1 knob: **ENABLE/DISABLE HARMONY VOICES**

EDIT 2 knob: **ENABLE/DISABLE LEAD VOICE THICKENING**

EDIT 3 knob: **ENABLE/DISABLE EFFECTS (Reverb and Delay)**

EDIT 4 knob: **ENABLE/DISABLE PITCH CORRECTION**



These parameters allow enabling/disabling of individual harmony voices. Voices and Effects LEDs will reflect the settings of this page.

EDIT 1 knob: **ENABLE/DISABLE VOICE 1**

EDIT 2 knob: **ENABLE/DISABLE VOICE 2**

EDIT 3 knob: **ENABLE/DISABLE VOICE 3**

EDIT 4 knob: **ENABLE/DISABLE VOICE 4**

# PRESET EDIT SCREENS

## Voice Edit Screens

VoiceLive can create up to 4 harmony voices. The parameters in this section allow adjustment of the individual voices.



This screen is used to set the output level of the individual harmony voices. Please note that there is also a master harmony voice level found on edit screen *HR 1*.

EDIT 1 knob: **VOICE 1 LEVEL**

EDIT 2 knob: **VOICE 2 LEVEL**

EDIT 3 knob: **VOICE 3 LEVEL**

EDIT 4 knob: **VOICE 4 LEVEL**



This screen is used to set the pan position of the individual harmony voices.

EDIT 1 knob: **VOICE 1 PANNING**

EDIT 2 knob: **VOICE 2 PANNING**

EDIT 3 knob: **VOICE 3 PANNING**

EDIT 4 knob: **VOICE 4 PANNING**



This screen is used to set the voicing of the four harmony voices. Voicing means setting the harmony voice note/pitch with respect to the lead note/pitch. This parameter means different things for different harmony modes. The harmony mode of the preset is shown on the LCD display.

EDIT 1 knob: **VOICE 1 VOICING**

EDIT 2 knob: **VOICE 2 VOICING**

EDIT 3 knob: **VOICE 3 VOICING**

EDIT 4 knob: **VOICE 4 VOICING**

*Note: the EDIT knobs will have no effect with Notes mode presets.*

# PRESET EDIT SCREENS

## Voicing in Scale Mode Presets

In this mode the **Voicing** parameter specifies the interval of the harmony note with respect to the input note in the scale. The range of values goes from **--8**, which is 2 octaves below the input note, to **++8** which is two octaves above the input note. For example, a setting of **+3** will result in a harmony voice a third above the input voice, related to the current scale.

## Voicing in Chord Mode Presets

In this mode the **Voicing** parameter specifies the relation of the harmony note to the input note with respect to the current chord. In chord mode presets, the harmony voices are always notes in the chord. A setting of **Up1** will result in the harmony voice being the next note above the input voice in the chord. For example, if the Chord was C Major and the input note was an E, an **Up1** setting would produce a G harmony voice, just above the input E. The range of values goes from **Dn5** (Down 5) to **U** (unison) to **Up6**. Additional values are **Rt1** and **Rt2** which give the decoded chord root as the harmony voice, and **Bs1** and **Bs2** (bass voicing) which give the lowest MIDI note received. **Rt2** and **Bs2** are the higher pitch root and bass settings.

## Voicing in Shift Mode Presets

In this mode the voices are shifted relative to the input note. The values range from **-24** semitones to **+24** semitones, shifted relative to the input note, creating parallel harmonies.

## Voicing Notes Mode Presets

In this mode a MIDI keyboard needs to be connected. On this screen you will see the currently decoded MIDI note for the selected voice.

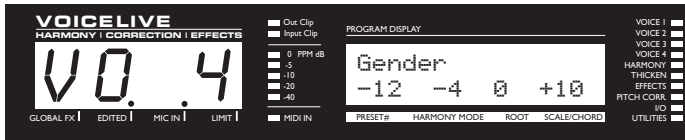

This screen is used to shift the formant (often called gender) of the Harmony Voices. Use it to alter the character of the voice ranging from **-50** (a big person with a deep voice) to **0** (no change) to **+50** (mice/alien sound).

EDIT 1 knob: **VOICE 1 GENDER**

EDIT 2 knob: **VOICE 2 GENDER**

EDIT 3 knob: **VOICE 3 GENDER**

EDIT 4 knob: **VOICE 4 GENDER**

# PRESET EDIT SCREENS

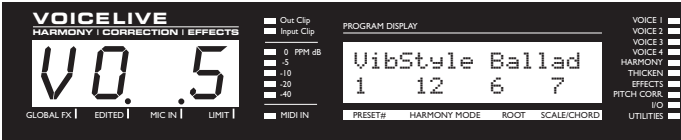

This screen is used to select a vibrato style for each harmony voice. The vibrato styles are based on the analysis of real singers. When changing the style number, the corresponding style description is displayed on the screen. Available Vibrato styles include:

- Ballad
- Tremolo
- RandVib (random depth and speed vibrato)
- Broadway
- Excited
- Folk
- Fast
- Warm
- Discreet
- Head
- RandTrem (random tremolo)
- Soprano

EDIT 1 knob: **VOICE 1 VIBRATO STYLE**

EDIT 2 knob: **VOICE 2 VIBRATO STYLE**

EDIT 3 knob: **VOICE 3 VIBRATO STYLE**

EDIT 4 knob: **VOICE 4 VIBRATO STYLE**



This screen is used adjust the amount of vibrato applied to each voice.

EDIT 1 knob: **VOICE 1 VIBRATO AMOUNT**

EDIT 2 knob: **VOICE 2 VIBRATO AMOUNT**

EDIT 3 knob: **VOICE 3 VIBRATO AMOUNT**

EDIT 4 knob: **VOICE 4 VIBRATO AMOUNT**

# PRESET EDIT SCREENS

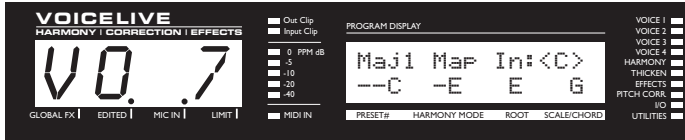

**CUSTOM VOICE MAPPING** (Scale Mode Only). Scale mode harmonies are basically pitch maps. For each input note in a scale you can define a resulting harmony note. VoiceLive has 3 major and 3 minor scale pitch maps for all scale roots, and intervals. The Custom voicing feature allows you to create your own pitch maps. For example, you could define a pitch map so that a C input produces an E output and a D input produces an A output. A good way to work with custom voicing is as follows:

- For a given harmony voice, select the scale root, type (*HA1* edit screen), and interval (*V03* edit screen) that most closely matches the desired voicing.
- Come back to this edit screen, press ENTER (the DATA WHEEL) and turn the DATA WHEEL TO select the input note that requires a different harmony note.
- Turn the EDIT KNOB that corresponds to the harmony voice that needs remapping.
- Select various other input notes by turning the DATA WHEEL and remap using the EDIT KNOBS as desired.
- Press ENTER to exit custom map editing.
- The custom map can be transposed under the Harmony Edit page 1 by changing the SCALE ROOT.

Pressing ENTER activates custom map editing. Pressing ENTER again exits custom map editing.

DATA WHEEL: Change input note for map editing

EDIT 1 knob: Voice 1 note mapped to input.

EDIT 2 knob: Voice 2 note mapped to input.

EDIT 3 knob: Voice 3 note mapped to input.

EDIT 4 knob: Voice 4 note mapped to input.

# PRESET EDIT SCREENS

## Harmony Edit Screens

The parameters in this section are used to set up basic harmony functions and adjust the overall sound of the harmonies.

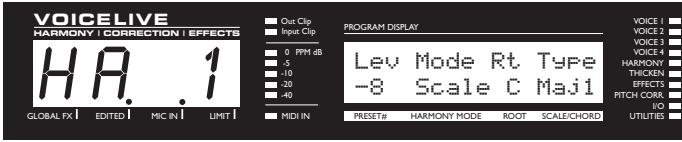

EDIT 1 knob: **HARMONY LEVEL**. Sets overall harmony level.

EDIT 2 knob: **HARMONY MODE**. Available settings:

- [Scale](#)
- [Chord](#)
- [Shift](#)
- [Notes](#)

**Note:** Changing the harmony mode will reset individual voice and harmony settings that are not applicable across different harmony modes.

EDIT 3 knob: **ROOT**. In Scale presets this sets the scale root. In Chord presets this sets the chord root.

EDIT 4 knob: **SCALE/CHORD**. In Scale presets this sets the scale type. In Chord presets this sets the chord type. (The Chord will change if incoming MIDI notes are detected as representing Valid chords).

See the "Harmony and Tuning" section of the manual for a full description of each harmony mode.

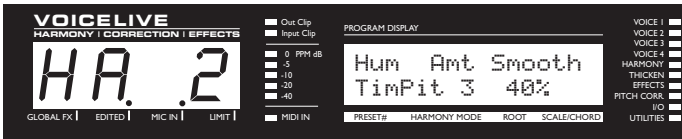

EDIT 1 knob: **HUMANIZATION STYLE**. This is a list of humanization style types. Each Style is made up from a combination of Flextime™ based time randomization, pitch randomization and pitch inflection (scoop). Available styles include:

- [ScpDwn](#) (Scoop down)
- [ScpUp](#) (Scoop up)
- [ScpTim](#) (Scoop and time randomization)
- [Loose](#) (Scoop, time and pitch randomization)
- [Timing](#) (time randomization)
- [TimPit](#) (time and pitch randomization)
- Pitch (pitch randomization)
- Detune (static detuning of the voices to a maximum of +25, -25, +19, -19 cents for the Voices 1-4 respectively).

EDIT 2 knob: **HUMANIZATION AMOUNT**. Sets the amount that the humanization style is applied to the harmony voices.

EDIT 3 knob: **SMOOTHING**. Sets how much of the input pitch nuance is applied to the output voice. Not applicable to Shift presets.

# PRESET EDIT SCREENS



- EDIT 1 knob: **LEAD VOICE ENABLE/DISABLE.** This allows turning the lead voice On or Off. This is useful in creating presets where you want to hear harmony voices only.
- EDIT 2 knob: **TUNING MODES.** This gives the option of either Equal temperament, Just intonation, or Barbershop tuning modes. See the “Harmony, and Tuning” section of the manual for a full description of each tuning mode.
- EDIT 3 knob: **LATCH MODE.** On or Off. When enabled in Chord mode, the last chord played remains active after the notes have been released from the MIDI keyboard. When enabled in Notes mode, the harmony voices will only respond to MIDI note input when the number of notes being played equals the harmony voices enabled. This ensures logical voice assignment when voices change. When Latch is On, the envelope parameters Attack and Release are not applicable.

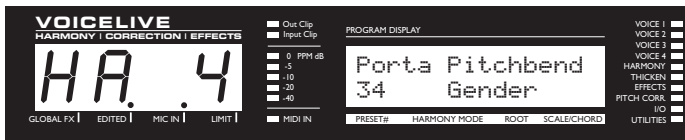

- EDIT 1 knob: **PORTAMENTO.** The time in milliseconds to reach a target note when a harmony voice changes pitch.
- EDIT 2 knob: **ASSIGN PITCHBEND WHEEL.** Allows assignment of the pitch bend wheel to the harmony voice pitch or gender.



- EDIT 1 knob: **ATTACK TIME.** Sets the envelope attack time in milliseconds for harmony voices. Available in Notes and Chords mode with LATCH set to Off (edit screen HA3).
- EDIT 2 knob: **RELEASE TIME.** Sets the envelope release time for harmony voices. Available in Notes and Chords mode with LATCH set to Off (edit screen HA3).

# PRESET EDIT SCREENS

## Thickening Edit Screen

A good portion of hit vocals use an effect similar to VoiceLive's thickening to add a stereo "shimmer" to the lead voice. The parameters in this section are used to set the thickening parameters.

### Thickening Block Diagram

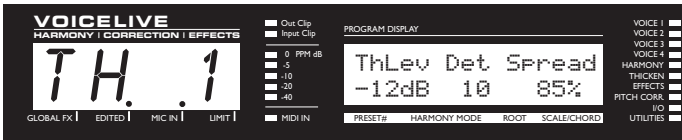
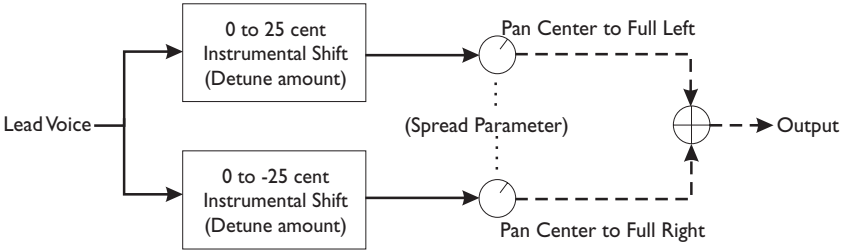

- EDIT 1 knob: **THICKEN LEVEL.** This sets the volume level of the lead voice thickening effect. Setting this between -6dB to 0dB gives a thick doubling or unmodulated chorus effect. Setting it between -10dB to -20dB gives the lead voice a subtle shimmer and creates a stereo quality.
- EDIT 2 knob: **DETUNE AMOUNT.** Sets the amount of lead voice detuning in cents. One voice is detuned above and one is detuned below by this amount.
- EDIT 3 knob: **SPREAD AMOUNT.** Sets the amount that the detuned voices are panned. A value of 100% results in the detuned voices being panned hard R and L. A value of 0% pans the detuned voices to center.

# PRESET EDIT SCREENS

## Effects Edit Screens

VoiceLive has a maximum of 1800 milliseconds of stereo delay time with filtering and 12 Reverb models. The parameters in this section provide control of these effects.

### Effects Block Diagram

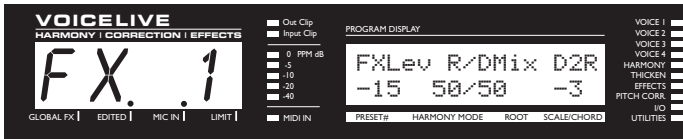
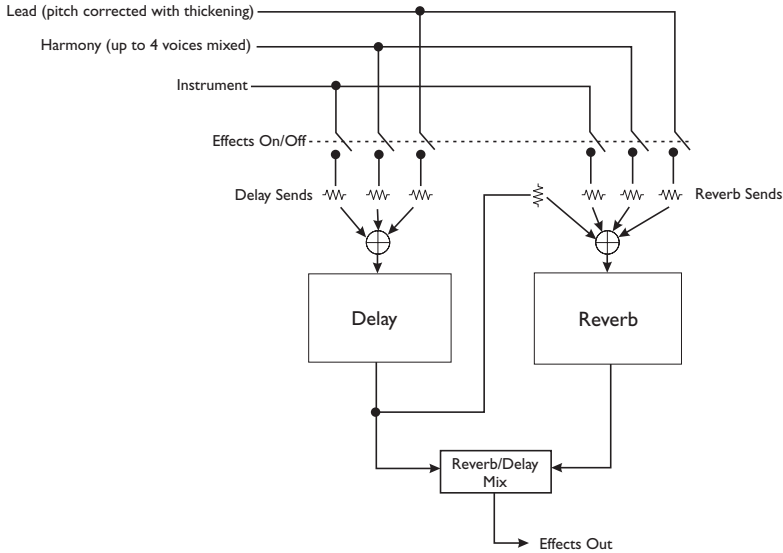

EDIT 1 knob: **EFFECT LEVEL.** This sets the overall volume of the combined Reverb and Delay effects.

EDIT 2 knob: **REVERB/DELAY MIX.**

EDIT 3 knob: **DELAY OUTPUT TO REVERB EFFECTS SEND LEVEL.**

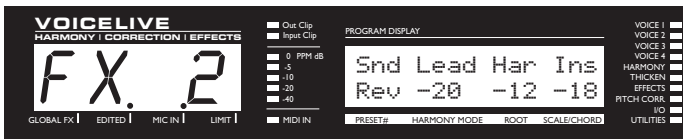

EDIT 1 knob: Used to select Reverb or Delay send parameters

EDIT 2 knob: **LEAD VOICE SEND LEVEL** in dB.

EDIT 3 knob: **HARMONY VOICES SEND LEVEL** in dB.

EDIT 4 knob: **INSTRUMENT SEND LEVEL** in dB.

# PRESET EDIT SCREENS



EDIT 1 knob: **REVERB TYPE**. Available reverb models include:

- [Living Room](#)
- [Chamber](#)
- [Club](#)
- [Classic Hall](#)
- [Concert Hall](#)
- [Large Cathedral](#)
- [Vocal Studio](#)
- [Vocal Room](#)
- [Vocal Hall](#)
- [Ambience](#)
- [Live Reverb](#)
- [Plate 1](#)
- [Plate 2](#)
- [Spring](#)

*Note: Changing the REVERB TYPE will affect the other reverb parameters.*



EDIT 1 knob: **REVERB DECAY TIME**.

EDIT 2 knob: **REVERB PRE-DELAY TIME**. Sets the delay time prior to the reverb output. Large rooms typically have reverbs that start much later than the initial signal.

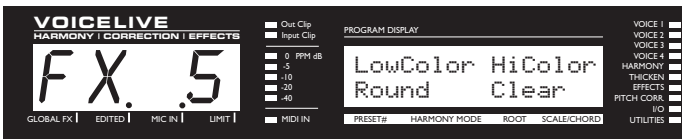

EDIT 1 knob: **REVERB LOW COLOR**. Sets the low frequency characteristics of the reverb.

EDIT 2 knob: **REVERB HIGH COLOR**. Sets the high frequency characteristics of the reverb.

# PRESET EDIT SCREENS



EDIT 1 knob: **DELAY TYPE.** Available parameters include:

- DualMono Delay- maintains the panning of the harmony, lead and instrument sends.
- PingPong1 sends the lead voice to the left effect send only and the instrument to the right send only. This results in the lead voice's first delay coming out of the right side and the instrument's coming out the left.
- PingPong2 sends the lead voice to the sends depending on the lead pan setting.

## Dual Mono Delay

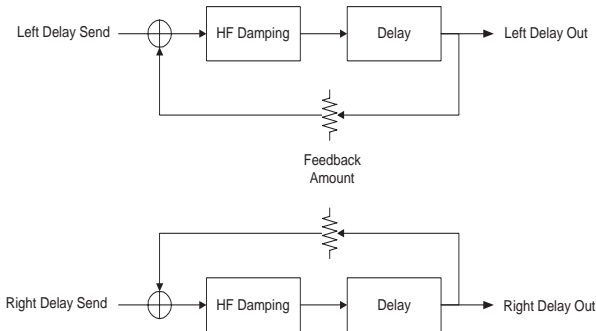

## PingPong1 and PingPong2 Delay

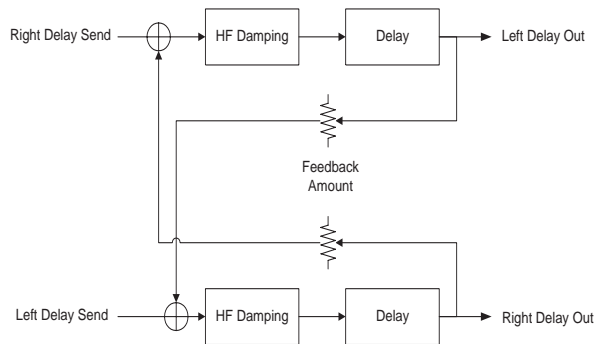

EDIT 2 knob: **DELAY FEEDBACK AMOUNT.** Increasing this value causes the delayed signal to take longer to fade out.

EDIT 3 knob: **HIGH FREQUENCY DAMPING.** Setting this to flat results in a delayed signal that is identical to the input. Setting this to 16k0 and lower values will simulate tape and is often preferred since it results in a delay that enhances the input without being distracting.

# PRESET EDIT SCREENS

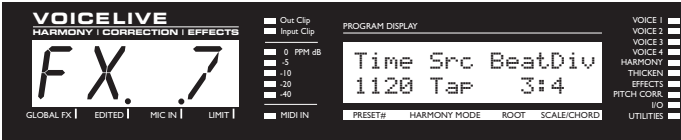

EDIT 1 knob: **DELAY TIME (ms)**. This can be used to manually set a delay time or adjust a delay time entered through tap tempo.

EDIT 2 knob: **DELAY TIME SOURCE**. Select from the following:

- **TAP**: the delay time comes from the last tapped tempo.
- **MCLK**: the delay time comes from incoming MIDI clock messages.
- **Manual**: the delay time always comes from the value manually entered into the preset using the DATA WHEEL.

EDIT 3 knob: **BEATS PER DIVISION**. This sets the ratio between the Tapped or MIDI tempo and the resulting delay.

*Note: Tempos can only be tapped in with the USER button. The USER button must be set up to do this. See edit screens [UBTN](#) and [UT2](#).*

# PRESET EDIT SCREENS

## Pitch Correction Edit Screens

VoiceLive will listen to the pitch of your voice, compare it to the selected correction scale, and then apply pitch correction in real-time. The amount of correction applied is governed by the various amount and timing settings.

In order to correct the pitch of a vocal, VoiceLive needs three pieces of information. It needs to know what pitch you are singing, it needs to know what pitch you would like to be singing, and it needs to know how perfectly you would like to be singing it. The first piece of information is determined automatically by VoiceLive as you sing using voice trained pitch detection algorithms. The second piece is supplied by you in the form of a set of possible target correction notes. VoiceLive looks at the set of supplied notes, listens to your vocal, and determines which note you are closest to at any given time. Depending on how you've configured the correction settings, VoiceLive will either subtly nudge your pitch, or aggressively force it to match the target note.

Pitch correcting your lead voice not only makes for great sounding lead vocals, it can also benefit your harmonies - pitch correction is applied prior to harmony voice generation.

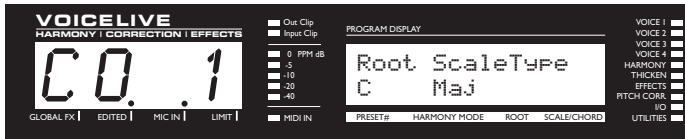

The best way to supply a set of target notes is in the form of a scale that matches the musicality of your vocal. The parameters in this screen let you do this. For example, you could select all of the notes of a C Major scale to be your target notes.

EDIT 1 knob: **PITCH CORRECTION SCALE ROOT.**

EDIT 2 knob: **PITCH CORRECTION SCALE TYPE.** Available options include:

- Maj (Major)
- Min1 (natural minor)
- Min2 (harmonic minor)
- Min3 (ascending melodic minor)
- Chro (Chromatic)
- Custom.

This setting in combination with scale root determines which notes your input vocal will be corrected to.

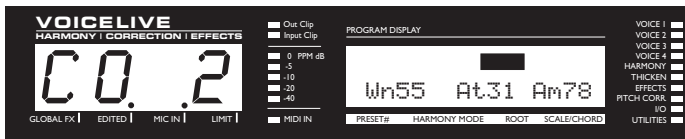

This screen gives access to parameters that determine how subtle or aggressive the pitch correction. The upper line of the display shows in real-time the pitch correction being applied by VoiceLive. The maximum correction displayed is +/- 200 Cents (there are 100 cents per semitone).

EDIT 1 knob: **WINDOW** (cents). When VoiceLive tries to determine which target note you are closest to, it uses this parameter. For example, if the set of correction notes includes "C, D, E, F, G, A, B" (C-major), and you are singing a very sharp D (80 cents sharp), the window dictates whether you should be corrected to D, or not at all. If the window was set to 80 or more cents, the D# would be corrected to the D

# PRESET EDIT SCREENS

because it falls within the window. If the window was less than 80 cents, no correction would take place. Your input pitch must fall within the window around one of the supplied correction notes if it is to be corrected at all. This allows you to naturally inflect your vocals and slide between notes while cleaning up the pitches as you get fairly close to them. A setting of 100 cents or larger will cause correction to be on continuously when using the scale C-Major, as 200 cents is the largest interval between any two notes.

**EDIT 2 knob: ATTACK.** Once the target correction pitch has been identified by VoiceLive, it begins to shift the pitch of your vocal at a rate determined by this parameter. A setting of 99 gives the fastest setting which instantaneously pulls your vocal in-tune, an effect that can be useful for some types of music. Settings between 16 and 40 give the most natural results.

**EDIT 3 knob: AMOUNT.** Scales the amount of automatic correction applied to the input voice. The range is 0% to 100%. However, 0% does not mean that the correction is turned off. The amount of applied correction depends on how far out of tune the input note is. This allows for a very musical way of correcting pitch. It corrects the large pitch errors while preserving the natural micro variations around the target pitch. For example:

With the amount set to 100%, a 10 cent flat input will be corrected by 10 cents and a 50 cent flat input will be corrected by 50 cents.

With the amount set to 80%, a 10 cent flat input will be corrected by approximately 5 cents and a 50 cent flat input will be corrected by approximately 40 cents.

With the amount set to 0%, a 10 cent flat input will not be corrected and a 50 cent flat input will be corrected by approximately 10 cents.

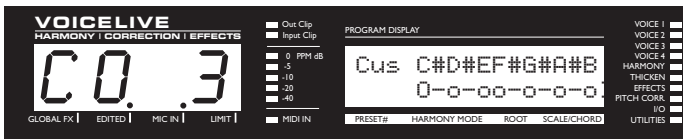

This screen shows the actual notes of the of current correction scale (Maj, Min1, Min2, Min3, Chrom or Cus). It provides a chromatic list of notes beginning with the scale root. Below this list a series of "o"s and "-s" indicating which notes are in the pitch correct scale and which are ignored. "o" indicates that the note is in the scale and "-" indicates that the note is ignored. The scale may be modified by moving the cursor to an "o" or "-" with EDIT 1 KNOB and turning the EDIT KNOB 2 to change its state. Modified (custom) scales are stored with presets.

**EDIT 1 knob:** Selects note.

**EDIT 2 knob:** Adds or removes note from the correction scale (selects either "o" or "-")

# PRESET EDIT SCREENS

## Special Edit Screens

The USER button and EXPRESSION pedal functions in VoiceLive give the performer foot control of their sound. They allow you to be your own sound man while you are performing. These special screens allow you to setup the USER button and EXPRESSION pedal in the preset.



EDIT 1 knob: **EXPRESSION PEDAL ASSIGN.** Assigns a parameter to be controlled by the Expression pedal. Options include:

- **Off.** This setting disables the operation of the expression pedal.
- **Lead Lev Full.** Control of lead voice level from off to maximum.
- **Harm Lev Full.** Control of harmony voice level from off to maximum.
- **Harm Lev Narrow.** Control of harmony voice level. Foot control range: -10dB to 0 dB with respect to other settings.
- **Inst Lev Full.** Control instrument output level (not input gain) from off to max. This is especially useful for performers with multiple instruments to mute the instrument signal when changing instruments.
- **Inst Lev Narrow.** Control of instrument output level (not input gain) from -10dB to max. The maximum position will give the same output level as set by the instrument level knob.
- **Voices 1+2 Lev.** Control of Voice 1 and Voice 2 level from off to the maximum level set in the preset.
- **Voices 3+4 Lev.** Control of Voice 3 and Voice 4 level from off to the maximum level set in the preset.
- **FX Level.** Control of Reverb and Delay level from off to the maximum in the preset.
- **Reverb level.** Control of reverb level from off to the maximum level set in the preset.
- **Delay Level.** Control of delay level from off to the maximum level set in the preset.
- **Vibrato.** Controls the vibrato intensity from minimum to maximum.
- **Smoothing.** Control of the smoothing parameter from 0 to 100.
- **Voicing Mirror.** Controls voicing of the harmonies (see edit screen *VO3*). At minimum expression pedal position the voicing is as in the preset; at center position the voicing is unison and at full position the voicing is the programmed interval on the opposite side of unison. This is useful for creative applications. With Shift mode presets you can use this to create extreme voice shift special effects. With Chord mode presets you can create voice appoggiator like effects.
- **Gender mirror.** Control of the four voice gender settings (see edit screen *VO4*). At minimum expression pedal position the gender is as in the preset (ie. 12); at center position the gender is 0 (no format shifting applied) and at full position the gender is minus the programmed interval (ie. -12).
- **Pan mirror.** Control of the four voice pan settings. At minimum expression pedal position the panning is as in the preset (ie. R45); at center position all pan settings are C (center) and at full position the pan setting is minus the programmed interval (ie. L45).
- **Default (UT1).** With this setting the expression pedal will default to settings in the *UT1* edit screen.

# PRESET EDIT SCREENS

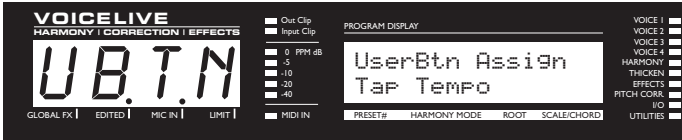

EDIT 1 knob: **USER BUTTON ASSIGN.** Assigns a parameter to be controlled by the USER button. Options include:

- Harmony Hold (Not Latching). For a complete description of Harmony Hold see the *Harmony and Tuning* section of the manual.
- Tap Tempo. The LED Displays TAP\* - the \* flashes the tempo. Please note that this setting will only have an effect on presets where the delay time source is set to TAP (see edit screen *FX7*). Tap tempo will be maintained in VoiceLive through preset changes. If multiple presets are used in a song with a given tempo, the delay time only needs to be tapped in once.
- FX Override – This controls turning on and off the Reverb and Delay effects.
- RevSend Override - Mutes and un-mutes the Reverb sends.
- DlySend Override - Mutes and un-mutes the Delay sends.
- Bypass Toggle – this is for people who do not like having to hold the harmony BYPASS button for bypass and would like to do it with a fast click.
- Harmony Override. Similar to pressing the harmony BYPASS button, except that this button can turn on harmonies from a preset that has them stored as off.
- PtchCor Override –Pitch Correction Enable/Disable.
- Thicken Override Enable/disable thickening
- RoboVoice - Enables pitch correction and overrides Window, Attack and Amount parameters to their maximum values which creates the “Cher” effect.
- TeleVoice All – Takes over the EQ parameters to make the voice sound telephone like. Affects the lead and harmony voices.
- TeleVoice Harm– Takes over the EQ parameters to make the harmony voices sound telephone like. Effects the harmony voices only.
- Momentary Harm - Harmonies are enabled only while this button is held.
- Default (UT2). With this setting the USER button will default to settings in the *UT2* edit screen.

# GLOBAL EDIT SCREENS

## IO Edit Screens

IO edit screens provide parameters that relate to general audio settings. All IO parameters are “global” in that they are not stored with the preset and are applicable to all presets. Press the STORE Key to save IO parameters after editing.

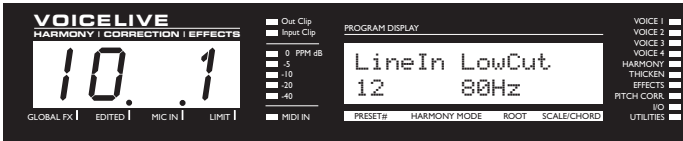

EDIT 1 knob: **LINE INPUT GAIN.** Sets the input gain for the line input.

EDIT 2 knob: **LOW CUT FILTER.** 12dB per octave. Cutoff frequency options include 60, 80 and 120 Hz.



EDIT 1 knob: **DRY LEAD ON/OFF.** Setting this to off removes the dry lead audio from the signal path. This is useful when using the signal from the Mic Pass Thru connector for the dry lead signal or when you want 100% wet output.

EDIT 2 knob: **DRY INSTRUMENT ON/OFF.** Setting this to off removes the dry instrument audio from the signal path. This allows VoiceLive to have an effects send from a mixing board feed the instrument input.



EDIT 1 knob: **LEAD VOICE PANNING.** This setting pans the lead voice.

EDIT 2 knob: **INSTRUMENT PANNING.** This setting pans the instrument.

EDIT 3 knob: **SYSTEM TUNING REFERENCE.** This sets the overall tuning reference with respect to A-440.

# GLOBAL EDIT SCREENS



VoiceLive has EQ and dynamics processing optimized for vocals. This screen and the following provide parameters for setting up the EQ and dynamics processing.

EDIT 1 knob: **DYNAMIC PROCESSING ASSIGN.** This allows assigning of dynamic processing (compressor and gate) to the lead voice, harmony voices, both lead and harmony voices or neither. Hint: assigning only to the lead voice with a medium compressor setting (threshold: -15dB, ratio:2:1) keeps the lead voice a consistent volume but setting harmony levels following the singers level. This gives control of harmony levels with mic technique.

EDIT 2 knob: **EQ ASSIGN.** This allows assigning of the three band EQ to the lead voice, harmony voices, both lead and harmony voices or neither.



Compressor / Gate settings. The compressor in VoiceLive has auto makeup gain to a maximum of +20dB. This means that the volume level of the signal will be increased for most volume levels of input with the compressor enabled.

EDIT 1 knob: **COMPRESSOR THRESHOLD LEVEL.** Range: 0 to -60 dB.

EDIT 2 knob: **COMPRESSION RATIO.** Range: 1.1:1 to 64:1

EDIT 3 knob: **GATE THRESHOLD.** Range: Off, -70dB to 0dB



VoiceLive has an extremely flexible 3 band EQ with frequency adjustable high and low shelving bands and a fully parametric band with Q, frequency and Gain controls. This screen gives control over the high and low shelf EQ parameters.

EDIT 1 knob: **LOW SHELF FREQUENCY (Hz).** Range: 80Hz to 16kHz

EDIT 2 knob: **LOW SHELF CUT/BOOST (dB).** Range: Cut (12 dB per octave low cut at the LOW SHELF FREQUENCY), -12dB to +12dB

EDIT 3 knob: **HIGH SHELF FREQUENCY (Hz).** Range: 80Hz - 16kHz

EDIT 4 knob: **HIGH SHELF CUT/BOOST (dB).** Range: Cut (12 dB per octave high cut at the HIGH SHELF FREQUENCY), -12dB to +12dB.

# GLOBAL EDIT SCREENS

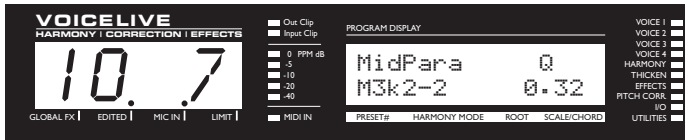

This screen provides control of the fully parametric mid EQ.

EDIT 1 knob: **CENTER FREQUENCY (Hz)**

EDIT 2 knob: **Cut/BOOST (dB)**

EDIT 3 knob: **Q**. This value is equal to the center frequency of the filter divided by the difference between the upper and lower -3dB frequencies. The higher the Q value the narrower the filter. Range is 1 (wide band) to 10 (very narrow band).



EDIT 1 knob: **BYPASS MODE**. This sets how VoiceLive operates in Bypass as controlled by the footswitches. The Stage setting disables all effect processing except for EQ and Dynamics processing. The Studio setting removes all effect processing including the EQ and Dynamics and outputs the lead signal at full level to the digital output.

EDIT 2 knob: **DELAY COMPENSATION**. Turning this on delays the lead vocal so that the humanized harmony voices will be randomly ahead and behind the lead voice. Turning this off results in minimum lead voice processing delay.

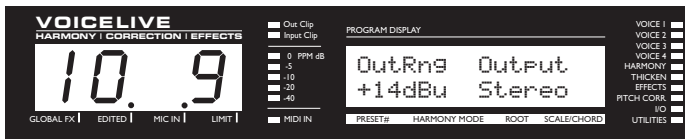

EDIT 1 knob: **OUTPUT RANGE**. This sets the output level range. The value displayed reflects the maximum output level at that setting. Please note that some mixers will produce a distorted signal with a +20dB signal. If you experience distortion and neither the input nor output clip lights are flashing on VoiceLive, try adjusting this parameter to a lower setting.

EDIT 2 knob: **OUTPUT MODE**: Stereo or Mono.

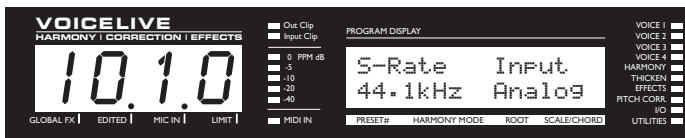

EDIT 1 knob: **SAMPLE RATE**: 44.1kHz, 48kHz or External.

EDIT 2 knob: **INPUT SELECT**: Analog or Digital.

# GLOBAL EDIT SCREENS

## Utility Edit Screens

Utility screens provide parameters that relate to the general setup of VoiceLive. All Utility parameters are “global” in that they are not stored with the preset and are applicable to all presets.



This screen sets the default expression pedal function. In the preset if the expression pedal is set to default, then the expression pedal assignment will come from this screen.

EDIT 1 knob: **EXPRESSION PEDAL DEFAULT ASSIGN.** Assigns a parameter to be controlled by the Expression pedal. Options include:

- **Lead Lev Full.** Control of lead voice level from off to maximum.
- **Harm Lev Full.** Control of harmony voice level from off to maximum.
- **Harm Lev Narrow.** Control of harmony voice level. Foot control range: -10dB to 0 dB with respect to other settings.
- **Inst Lev Full.** Control instrument output level (not input gain) from off to max. This is especially useful for performers with multiple instruments to mute the instrument signal when changing instruments.
- **Inst Lev Narrow.** Control of instrument output level (not input gain) from -10dB to max. The maximum position will give the same output level as set by the instrument level knob.
- **Voices 1+2 Lev.** Control of Voice 1 and Voice 2 level from off to the maximum level set in the preset.
- **Voices 3+4 Lev.** Control of Voice 3 and Voice 4 level from off to the maximum level set in the preset.
- **FX Level.** Control of Reverb and Delay level from off to the maximum in the preset.
- **Reverb level.** Control of reverb level from off to the maximum level set in the preset.
- **Delay Level.** Control of delay level from off to the maximum level set in the preset.
- **Vibrato.** Controls the vibrato intensity from minimum to maximum.
- **Smoothing.** Control of the smoothing parameter from 0 to 100.
- **Voicing Mirror.** Controls voicing of the harmonies (see edit screen *VO3*). At minimum expression pedal position the voicing is as in the preset; at center position the voicing is unison and at full position the voicing is the programmed interval on the opposite side of unison. This is useful for creative applications. With Shift mode presets you can use this to create extreme voice shift special effects. With Chord mode presets you can create voice arpeggiator like effects.
- **Gender mirror.** Control of the four voice gender settings (see edit screen *VO4*). At minimum expression pedal position the gender is as in the preset (eg. 12); at center position the gender is 0 (no format shifting applied) and at full position the gender is minus the programmed interval (eg. -12).
- **Pan mirror.** Control of the four voice pan settings. At minimum expression pedal position the panning is as in the preset (eg. R45); at center position all pan settings are C (center) and at full position the pan setting is minus the programmed interval (eg. L45).

# GLOBAL EDIT SCREENS

- Off. This setting disables the operation of the expression pedal.



This screen sets the default USER button function. In the preset if the USER button is set to default, then the USER button assignment will come from this screen.

EDIT 1 knob: **USER BUTTON DEFAULT ASSIGN.** Assigns a parameter to be controlled by the User Button. Options include:

- Harmony Hold (Not Latching). For a complete description of Harmony Hold see the *Harmony and Tuning* section of the manual.
- Tap Tempo. The LED Displays TAP\* - the \* flashes the tempo. Please note that this setting will only have an effect on presets where the delay time source is set to TAP (see edit screen FX7). Tap tempo will be maintained in VoiceLive through preset changes. If multiple presets are used in a song with a given tempo, the delay time only needs to be tapped in once.
- FX Override – This controls turning on and off the Reverb and Delay effects.
- RevSend Override - Mutes and un-mutes the Reverb sends.
- DlySend Override - Mutes and un-mutes the Delay sends.
- Bypass Toggle – this is for people who do not like having to hold the harmony BYPASS button to bypass and would like to do it with a fast click.
- Harmony Override. Control of Reverb and Delay level from off to the maximum in the preset.
- PtchCor Override –Pitch Correction Enable/Disable.
- Thicken Override Enable/disable thickening
- RoboVoice - Enables pitch correction and overrides Window, Attack and Amount parameters to their maximum values which creates the “Cher” effect.
- TeleVoice All– Takes over the EQ parameters to make the voice sound telephone like. Affects the lead and harmony voices.
- TeleVoice Harm– Takes over the EQ parameters to make the harmony voices sound telephone like. Effects the harmony voices only.
- Momentary Harm- Harmonies are enabled only while this button is held.

# GLOBAL EDIT SCREENS



EDIT 1 knob: **GLOBAL EFFECTS PRESET SELECT.** This makes the effect parameters of the chosen preset global for all recalled presets and Song steps.

EDIT 2 knob: **VIBRATO CONTROL.** This sets whether the vibrato follows the onset and attack of the model (Boost) or is instantaneous (Manual). The Mod Wheel on most keyboards controls the vibrato in both modes, boosting the preset value in the Boost setting and starting from a value of 0 in the Manual Setting.

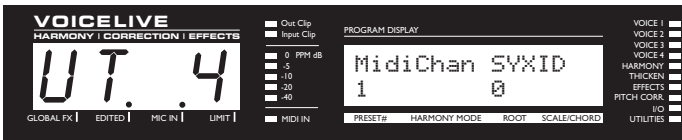

EDIT 1 knob: **MIDI CHANNEL.** Sets the base MIDI Send and Receive channel.

EDIT 2 knob: **SYSTEM EXCLUSIVE ID.** This parameter sets the MIDI system exclusive ID for VoiceLive.

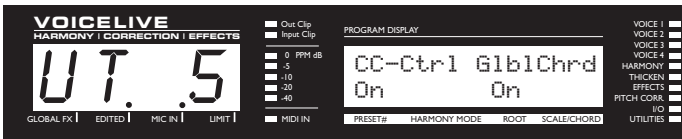

EDIT 1 knob: **MIDI CC CONTROL.** On: sends and responds to MIDI CC messages. Off: MIDI CC messages not sent or responded to.

EDIT 2 knob: **GLOBAL CHORD.** Options are as follows:

- On - The last MIDI detected chord type and root is retained when switching through chordal presets.
- Off - The chord type and root is always taken from the preset recalled.

# GLOBAL EDIT SCREENS

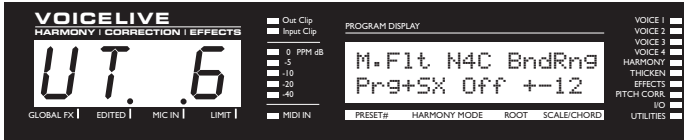

EDIT 1 knob: **MIDI FILTER.** With this parameter you can cause VoiceLive to ignore certain MIDI commands and data.

- P - ignore program changes.
- SX - ignore system exclusive messages.
- P+SX -ignore program changes and system exclusive messages.

EDIT 2 knob: **NOTES FOUR CHANNEL MODE.**

- Off - All harmony voices in Notes Mode will respond to the base MIDI channel.
- On - In Notes mode, Harmony Voice 1 responds to the base MIDI channel; Harmony Voice 2 responds to the base MIDI channel +1 etc. All Harmony Voices will respond to unique MIDI channels.

EDIT 3 knob: **BEND RANGE.** Sets in semitones the range that MIDI pitch bend information will alter the pitch of the harmonies in Notes mode.

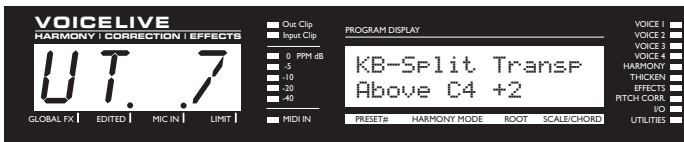

The parameters on this screen allow keyboard players to specify a range of the keyboard to control Notes and Chord mode harmonies. For example using a combination of the three controls below, a user can set the top octave of the keyboard to play notes mode harmonies.

EDIT 1 knob: **MIDI SPLIT ABOVE/BELOW.** Sets whether notes above or below the split point are used for notes mode and chord mode presets.

EDIT 2 knob: **MIDI SPLIT POINT.**

EDIT 3 knob: **MIDI TRANSPOSE.** This transposes the harmony voices in Notes mode. The value corresponds to octaves.

# SONG MODE

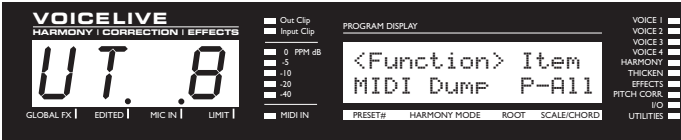

In this screen the selection from the first knob affects the options in the second knob. Once you have made the selections you must press the DATA WHEEL for ENTER to perform the function.

EDIT 1 knob selection: MIDI Dump. Allows SYSEX MIDI dumping of all or individual presets, all or individual Songs and the VoiceLive IO/Util parameters.

- Select what you would like to backup using the EDIT2 KNOB. Pn denotes a preset; Sn Denotes a song; Setup is all IO/Util parameters.
- If connected to another VoiceLive simply press ENTER and your data will be copied to the other VoiceLive.
- If connected to a sequencer, arm it to record SYSEX data and press ENTER on VoiceLive.

EDIT 1 knob selection: RestorePre. Restore a Preset to its Factory setting.

- Select what preset you would like to restore using the EDIT2 knob.
- Press ENTER to restore the preset.

EDIT 1 knob selection: RestoreSng. Restore a Song to its Factory setting.

- Select what Song you would like to restore using the EDIT2 knob.
- Press ENTER to restore the song.

EDIT 1 knob selection: ClearSng. Clear song steps and name of a song.

- Select what song you would like to clear using the EDIT2 knob.
- Press ENTER to clear the song.



VoiceLive will operate properly with most passive volume and expression pedals. Use this screen to calibrate the pedal. To calibrate the expression pedal follow instructions on the VoiceLive LCD display:

With the expression pedal plugged into the Pedal Input on the back of VoiceLive press the DATA wheel for ENTER.

- Move the pedal to its MAXIMUM position.
- Press the data wheel for ENTER.
- Move the pedal to it's MINIMUM position.
- Press the data wheel for ENTER.

# SONG MODE

## SONG MODE

Song mode is VoiceLive's advanced performance mode. You can pre-program a sequence of presets, scale, root, or chord changes, and step forwards and backwards through them as needed as well as jump directly to song steps in Direct mode - all with foot control. There is a maximum of 50 songs in VoiceLive with 30 steps each.

This feature also allows you to use a single preset throughout a sequence of footswitch steps while changing only the musical information - the chord, root, and type information in chordal presets, and the key and scale information in scalic presets.

*To enter **Song Mode** hold the SONG button (2) until the LED text display flashes SONG.*

### Song Mode LCD Screen:

```
33: Happy Joe  
S2 P53s C#Maj2
```

The LCD display above is an example of a Song mode screen.

Here's what it all means.

- Top Line Song number and name
- S2 Step number.
- P53s Preset number and harmony type. s= Scale; c= Chord; n= notes; blank =shift.
- C# Maj2 Root and Scale/chord type for scale and chord mode presets.

*To access the Song Edit screen press the EDIT key while in Song Mode.*

### Song Edit Mode LCD Screen:

```
Sng33 <STEP INS>  
S21 P53s C#Maj2
```

The LCD display above is an example of a Song edit screen.

Here's what it all means.

- Sng33 Song number
- <Step INS> Song Edit Function. This is selectable by turning the data wheel and is executed by pressing the data wheel (ENTER).
- S21 Step number. Change the step number using the EDIT 1 knob.
- P53s Preset number and harmony type. s= Scale; c= Chord; n= notes; blank =shift. The preset number may be edited using the EDIT 2 knob.
- C# Scale/Chord Root for scale and chord mode presets. This may be changed using the EDIT 3 knob.
- Maj2 Scale/Chord Type for scale and chord mode presets. This may be changed using the EDIT 4 knob.

# SONG MODE

## Song Edit Functions

Turn the data wheel to select between the following two Song Edit Functions:

<STEP INS> inserts a copy of the current step.

<STEP DEL> deletes the current step.

Press ENTER to execute the function.

*Once you have created a Song, remember to press the STORE key to save your work.*

## Song Mode LED Displays

SG31

Above is an example of a Song Select LED text display.

SG Indicates that you are in Song select mode.

31 Song number.

Pressing the PREVIOUS/NEXT buttons (5,6) will change the song number.

When in Song Mode you can get there by pressing the SELECT button (1).

ST21

Above is an example of a Song Step Display.

ST Indicates that you are in Song step mode.

21 Song step number.

Pressing the PREVIOUS/NEXT buttons (5,6) will change the step number.

When in Song Mode you can get there by pressing the STEP button (2).

# SONG MODE

## Song Direct Mode

To enter **Song Direct Mode**, you need to be in Song Mode, then hold the **DIRECT** button (3) until the LED text display flashes **DRCT**.

**SA21**

Above is an example of a Song Direct Mode LED text display

**S** This character means that you are in Song Mode.

**A** This character means that you are in Direct Submode as well as:

- If it's an A,B, C or D then a Direct Step has just been recalled by pressing one of corresponding top four **DIRECT** buttons. In this case holding one of the top four buttons will change the mode of VoiceLive operation.
- If it's a \* then holding one of the top four buttons will program the current step to the button held.

**21** This indicates the current Song step.

Pressing the **DIRECT** buttons (1-4) will jump to the programmed step.

Holding the **DIRECT** buttons (1-4) will either program the current step to that Direct Button (when the second LED character is a \*) or change the mode of operation of VoiceLive.

**PREVIOUS/NEXT** buttons (5, 6) changes the Song step. When this happens the second character on the LED display changes to a \*, indicating that a **DIRECT** button may be programmed.

## Song Voice Mode

To enter **Song Voice Mode**, you need to be in Song Mode, then hold the **VOICE** button (4) until the LED text display flashes **VOIC**.

**SV21**

Above is an example of a Song Select LED text display.

**S** This character means that you are in Song Mode.

**V** This character means that you are in Voice Submode.

**21** This indicates the current Song step.

Pressing the **VOICE** buttons (1-4) will enable/disable the individual harmony voices.

Holding the **VOICE** buttons (1-4) will change the mode of operation of VoiceLive.

Pressing the **PREVIOUS/NEXT** buttons (5, 6) changes the Song step. The enabled/disabled combinations of the voices are maintained as Song steps are changed.

# HARMONY AND TUNING

## Harmony

Here's where we can go into a little more depth about harmonies. We've tried to keep it practical, focusing on what VoiceLive can do for you.

### Harmony Hold

Truly an innovation, the Harmony Hold feature lets you (on a whim) sustain the backing harmony voices while you continue to sing through them. On activation (assign the USER button to this function in either edit screen *UBTM* or *UT2* and press and hold or use the Harmony Hold MIDI CC), you can freeze whatever the harmony voices are doing, and they will hold their notes (in a very natural way) until you let go (of the PEDAL button or by sending the proper CC value). See edit screen *UBTM* description in the "Preset Edit Screen" section of the manual and the "MIDI Implementation" section of the manual for more information.

### Harmony Modes

VoiceLive has four different harmony modes, which give you four unique methods of creating harmony. Once we get into describing the more complex harmony modes, we'll be showing you examples based on the C major scale. If you are unfamiliar with this scale we've shown C major here.



### Notes Mode

In this Mode, you provide VoiceLive with specific MIDI note information to determine the pitch of the harmony voices. VoiceLive has two "Manual/Notes" harmony modes, single and 4 channel. VoiceLive may be set to Notes 4 Channel mode through the **Edit Screen UT6**. Notes 4 Channel mode allows you to send 4 channels of MIDI information, one for each individual harmony voice. This is the most direct and flexible way of creating harmonies, allowing you to weave complex melodies and counter harmonies irrespective of your lead vocal.

### Shift Mode

Also known as "Fixed Interval", this takes the pitch of your lead voice and creates harmonies

a set number of semitones away, based on that pitch. The method of creating harmonies, using a fixed number of semitones relative to an input note or pitch, is called chromatic harmony, the theory of which we'll go into later. We consider this type of harmonizing to be non-intelligent because VoiceLive is not set to any particular key or scale. These are pure, parallel harmonies. The most common shift harmony voices are the 5th (7 semitones) and octave (12 semitones), ranging from two octaves below the input to two octaves above the input pitch.

Below is The C Major scale, showing third above chromatic scale harmony, as used in VoiceLive Shift Mode.



Black = Lead & Grey = Harmony

### Chord (Chordal) Mode

Chordal harmonies take your chord information to create intelligent, diatonic harmonies based on your voice. To make "Chordal" harmonies, you need to input in real time the chords of the song. This may be done either via MIDI or through a programmed sequence of chord roots and types in **Song mode**. Chord information consists of the chord root and type, which define the 3 or 4 notes in a given chord. In Chordal mode the VoiceLive will only create harmony voices that fall on the notes of the chord. Chordal harmonies are "intelligent" because they decipher the chord you're playing and the note you're singing to produce musically pleasing harmonies. When 1 above is defined as a harmony voice (**Up1**), the next note from the chord above the input note is output for that harmony voice.

The subsequent illustration shows the harmony notes for the C major scale with a voicing selection of a C major chord and a single "one above".

Root: C, Chord Type: Maj, Voicing: Up1

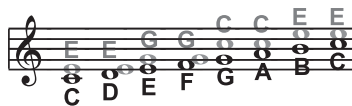

# HARMONY AND TUNING

Black = Lead & Grey = Harmony

You might have noticed that each harmony note can cover more than one input note, or that each input note doesn't necessarily have a unique harmony note. For instance, C and D both have E as the 3rd above, E and F share G, and so on. This gives a more stepped sound to the harmony as the changes are both greater in magnitude and less frequent than when using other harmony methods (shift mode for example). The benefit of this method is that it is very easy to integrate vocal harmonies into your songs if you already know their chord progressions! The following lists the chords available with respect to the root of "C":

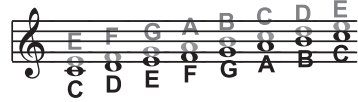

Black = Lead & Grey = Harmony

Under the Harmony Edit Screen HA2, is a parameter called SMOOTHING. When set to 100% the harmony voices follow your input pitch, errors and all, but when set to 0% the harmonies will jump directly to the scalar harmony notes, kind of like a hard pitch correction on the harmony voice. Setting the SMOOTHING parameter between 0 and 100% is like having variable amounts of pitch correction on the harmonies. VoiceLive has six preprogrammed harmony scales: three major, three minor and one custom per preset. *To create a custom scale or pitch map see the "Custom Voice Mapping" section in the "Preset Edit Screens" part of this manual.*

It is also tricky to pick out the key in some songs. An example is "Sweet Home Alabama". Listening, you might think this song is in the key of "D", as that's the first chord, but the harmonies actually work best in the key of "G" -- try running the song through VoiceLive to hear for yourself.

Setting the scale can also take a bit of practice: for songs centered around the third or root of the scale it might not sound like there's any noticeable differences between the three major or three minor scales. This is because your song doesn't hit any of the scale's altered notes. A melody centered around the fifth of the scale, (such as B in the key of E), highlights the differences between the scales. Try the "Sha Lala Lala ...La Tee Daa" chorus of Van Morrison's "Brown Eyed Girl" (key: E, scale: major, 3rd above voicing) with each major scale to hear the audible difference between them. For the minor scales, Santana's "Evil Ways" (key: G, scale: minor, 3rd above voicing) highlights the differences between the three minor scales.

The following table illustrates the third and fifth above for a given input note to illustrate the differences between the six different scales. "nc" means no change, in that the harmony voice will simply keep its previous pitch until the lead voice pitch changes to a non "nc" note.

|          |   |                |                |                                  |
|----------|---|----------------|----------------|----------------------------------|
| Maj      | C | E              | G              |                                  |
| Maj6     | C | E              | G              | A                                |
| Maj7     | C | E              | G              | B                                |
| Maj7sus4 | C | F              | G              | B                                |
| Min      | C | E <sup>b</sup> | G              |                                  |
| Min6     | C | E <sup>b</sup> | G              | A                                |
| Min7     | C | E <sup>b</sup> | G              | B <sup>b</sup>                   |
| Min7b5   | C | E <sup>b</sup> | G <sup>b</sup> | B <sup>b</sup>                   |
| Dim      | C | E <sup>b</sup> | G <sup>b</sup> |                                  |
| Dim7     | C | E <sup>b</sup> | G <sup>b</sup> | B <sup>bb</sup><br>(equiv. to A) |
| Dom7     | C | E              | G              | B <sup>b</sup>                   |
| Dom7b5   | C | E              | G <sup>b</sup> | B <sup>b</sup>                   |
| Aug      | C | E              | G <sup>#</sup> |                                  |
| Aug7     | C | E              | G <sup>#</sup> | B <sup>b</sup>                   |
| Sus      | C | F              | G              |                                  |
| Sus2     | C | D              | G              |                                  |
| Sus7     | C | F              | G              | B <sup>b</sup>                   |

## Scale (Scalic) mode

Harmonies use key and scale information to create musically correct, diatonic harmonies. Most popular music uses a single scale, so you usually only have to input the information at the beginning of your song. "Scalic" harmonies are more dynamic than the chordal harmonies because there are unique harmony notes for each input note. The subsequent illustration shows the harmony notes for the C major scale with a voicing selection of a C major scale and a single "third above" harmony voice. You can see from the next diagram that the "Scalic" harmonies are intelligent and closely follow your lead voice for a tighter sound.

# HARMONY AND TUNING

|             | Lead Voice | C         | C# | D         | E $\flat$ | E         | F         | F# | G         | G#        | A  | B $\flat$ | B  |
|-------------|------------|-----------|----|-----------|-----------|-----------|-----------|----|-----------|-----------|----|-----------|----|
| <b>MAJ1</b> | 3rd Above  | E         | nc | F         | nc        | G         | A         | nc | B         | nc        | C  | D         | D  |
|             | 5th Above  | G         | nc | A         | nc        | B         | A         | nc | D         | nc        | E  | F         | F  |
| <b>MAJ2</b> | 3rd above  | E         | nc | F         | nc        | G         | A         | nc | C         | nc        | C  | D         | D  |
|             | 5th above  | G         | nc | A         | nc        | C         | C         | nc | E         | nc        | E  | F         | F  |
| <b>MAJ3</b> | 3rd above  | E         | nc | F         | nc        | G         | A         | nc | B $\flat$ | nc        | C  | D         | D  |
|             | 5th above  | G         | nc | A         | nc        | B $\flat$ | C         | nc | B $\flat$ | nc        | E  | F         | F  |
| <b>MIN1</b> | 3rd above  | E $\flat$ | nc | F         | G         | nc        | A $\flat$ | nc | B $\flat$ | C         | nc | D         | nc |
|             | 5th above  | G         | nc | E $\flat$ | nc        | nc        | C         | nc | D         | E $\flat$ | nc | F         | nc |
| <b>MIN2</b> | 3rd above  | E $\flat$ | nc | F         | G         | nc        | A         | nc | B $\flat$ | C         | nc | D         | nc |
|             | 5th above  | G         | nc | A         | B $\flat$ | nc        | C         | nc | D         | E $\flat$ | nc | F         | nc |
| <b>MIN3</b> | 3rd above  | E $\flat$ | nc | F         | G         | nc        | A $\flat$ | nc | B         | C         | nc | D         | nc |
|             | 5th above  | G         | nc | A         | B $\flat$ | nc        | C         | nc | D         | E $\flat$ | nc | F         | nc |

## Diatonic and Chromatic

We've described scalic and chordal harmonies as diatonic, and shift harmonies as chromatic; but what do those words mean?

Look at a piano keyboard. Between middle "C" and the next "C" there are twelve keys - 7 white keys and 5 black keys. Each of those keys are pitched one semitone apart for a total of, you guessed it, 12 semitones. The chromatic scale uses all twelve semitone notes opposed to the diatonic scales. Thus there is only one chromatic scale, but 12 each of the major, minor, etc. diatonic scales (C major, C# major, D major, etc). Most of us have grown up hearing the traditional "doh ray me fah so la tee doh" diatonic scale, so that harmonies based on the diatonic scale sound correct. What does this mean, harmony-wise?

Diatonic scale harmonies can only use notes within specified scale or chord, so a "third above" harmony voice actually varies between 3 and four semitones above the lead note where the chromatic harmony would stay exactly 4 semitones (a major 3rd) above each note.

To recap: we have three different harmony modes that use chromatic or diatonic scales.

**Shifting**, which uses the chromatic, 12 semitone scale, changes the input pitch by a fixed number of semitones:

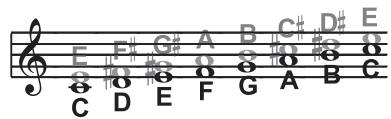

**Chordal**, which uses the root, third, fifth and sometimes seventh of the many diatonic scales, pitches the harmony voice to the closest note contained within the chord:

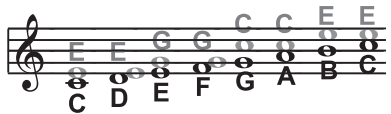

**Scalic**, which uses one of many diatonic scales, pitches the harmony voice to the nearest note contained within the scale:

# HARMONY AND TUNING

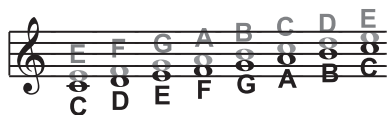

Theory aside, the best way to get great sound is to experiment with all of VoiceLive's possible harmony modes. Not only will you develop an intuitive sonic sense of what works best where, but by investigating different permutations and combinations you could discover some delightful sounds you might otherwise have missed.

## Just Tuning

Why just tuning? Although probably no one has ever told you this, your expensive grand piano and the last great keyboard synthesizer you bought are both out of tune! Well, to be fair we can say instead that they are all tuned using Equal temperament.

Harmony is the result of the interaction between differing audible frequencies in ratios that sound musical to the human ear. A more exact ratio leads to a nicer sounding harmony. Most instruments (like the piano) are absolute by nature. Each note on the keyboard has a specific pitch. Equal temperament tuning uses approximations for the tuning of each note, allowing us to easily alter the key of our music without re-tuning our instruments.

Unfortunately, with this method of tuning we lose the ability to create perfect ratios when playing multiple notes. As a result, much of the harmony you've heard in music has not been perfectly in tune!

The bottom line is that the approximations of equal temperament tuning are practical, but imperfect. Using VoiceLive with Just tuning will definitely expand your musical horizons!

Just tuning is practice of maintaining the relative (and perfect) ratios between pitches, creating perfect harmonies.

Singers, especially when performing multi-part a cappella music, base their tuning on how it harmonically sounds with other singers. The

natural tendency, and what sounds best, is to sing with "just tuning" so that beating is minimized. One of the goals in barbershop quartet singing is to strive for "just relative intonation" so that a sub-frequency is audible. Achieving this goal results in what barbershop fans often describe as the coveted "ring and lock" sound. In barbershop music it is the lead singer's responsibility to try to sing the melody as close to the tuning of a piano (equal temperament) as possible. The other singers must then tune their harmonies to the melody using "just relative intonation". VoiceLive is able to do this in both the Just and Barbershop tuning modes.

Barbershop differs from Just tuning in Chordal mode. Just tuning will use the root of the chord for the tuning reference, while Barbershop tuning uses the input notes as the tuning reference. For this reason it is better to use Barbershop in an a-cappella situation and Just when playing with other instruments, because Just tuning sounds more in-tune with the other instruments that most likely have equal temperament tuning.

Our best advice is to experiment and use your ears!

# FOOTSWITCH FUNCTION TABLES

| Preset Mode Footswitch Functions: Buttons 1-4 |        |  |  |                          |   |
|---|--------|--|--|--------------------------|---|
| Submode                                       | Action | Button 1   | Button 2                                       | Button 3                 | Button 4  |
| Normal  | Press  | Preset Select                                    | Key Select                                     | Scale Select             | N/A   |
|   | Hold   | N/A  | Enter Song Mode                                | Enter Direct Mode        | Enter Voice Mode                                |
| Direct  | Press  | Recall Direct A Preset                           | Recall Direct B Preset                         | Recall Direct C Preset   | Recall Direct D Preset                          |
|   | Hold   | Program Direct A* Preset<br>OR Enter Preset Mode | Program Direct B* Preset<br>OR Enter Song Mode | Program Direct C* Preset | Program Direct D* Preset<br>OR Enter Voice Mode |
| Voice   | Press  | Enable/Disable<br>Voice 1                        | Enable/Disable Voice 2                         | Enable/Disable Voice 3   | Enable/Disable Voice 4                          |
|   | Hold   | Enter Preset Mode (leave<br>Voice Submode)       | Enter Song Mode                                | Enter Direct Mode        | Enter Voice Mode                                |

| Preset Mode Footswitch Functions: Buttons 5-8 |        |   |  |                       |                                |
|---|--------|---|--|-----------------------|--------------------------------|
| Submode                                       | Action | Button 5  | Button 6                                   | Button 7              | Button 8                       |
| Normal  | Press  | Decrement Preset#, Key, or<br>Scale               | Increment Preset#, Key, or<br>Scale        | User defined function | Mute/ Unmute Harmony<br>Voices |
|   | Hold   | Repeat Decrement Preset#,<br>Key, or Scale Repeat | Increment Preset#, Key, or<br>Scale Repeat | User defined function | Bypass/ Unbypass               |
| Direct  | Press  | Decrement Preset#                                 | Increment Preset#                          | User defined function | Mute/ Unmute Harmony<br>Voices |
|   | Hold   | Repeat Decrement Preset#                          | Repeat Increment Preset#                   | User defined function | Bypass/ Unbypass               |
| Voice   | Press  | Decrement Preset#                                 | Increment Preset#                          | User defined function | Mute/ Unmute Harmony<br>Voices |
|   | Hold   | Repeat Decrement Preset#                          | Repeat Increment Preset#                   | User defined function | Bypass/ Unbypass               |

\* Direct buttons are programmed when the second character of the LED display is a **\***, otherwise the mode is changed.

# FOOTSWITCH FUNCTION TABLES

| Song Mode Footswitch Functions: Buttons 1-4 |        |   |   |                        |  |
|---|--------|---|---|------------------------|--|
| Submode                                     | Action | Button 1                                    | Button 2                                  | Button 3               | Button 4                                   |
| Normal                                      | Press  | Song Select                                 | Song Step Select                          | Rewind to Step 1       | N/A  |
|   | Hold   | Enter Preset Mode                           | N/A                                       | Enter Direct Mode      | Enter Voice Mode                           |
| Direct                                      | Press  | Goto Direct A Step                          | Goto Direct B Step                        | Goto Direct C Step     | Goto Direct D Step                         |
|   | Hold   | Program Direct A* Step OR Enter Preset Mode | Program Direct B* Step OR Enter Song Mode | Program Direct C* Step | Program Direct D* Step OR Enter Voice Mode |
| Voice                                       | Press  | Enable/Disable Voice 1                      | Enable/Disable Voice 2                    | Enable/Disable Voice 3 | Enable/Disable Voice 4                     |
|   | Hold   | Enter Preset Mode                           | Enter Song Mode                           | Enter Direct Mode      | Enter Voice Mode                           |

| Song Mode Footswitch Functions: Buttons 5-8 |        |                                 |                                 |                       |                             |
|---|--------|---------------------------------|---------------------------------|-----------------------|-----------------------------|
| Submode                                     | Action | Button 5                        | Button 6                        | Button 7              | Button 8                    |
| Normal                                      | Press  | Decrement Song# or Song Step#   | Increment Song# or Step#        | User defined function | Mute/ Unmute Harmony Voices |
|   | Hold   | Repeat Decrement Song# or Step# | Repeat Increment Song# or Step# | User defined function | Bypass/ Unbypass            |
| Direct                                      | Press  | Decrement Song Step#            | Increment Song Step#            | User defined function | Mute/ Unmute Harmony Voices |
|   | Hold   | Repeat Decrement Song Step#     | Repeat Increment Song Step#     | User defined function | Bypass/ Unbypass            |
| Voice                                       | Press  | Decrement Song Step Number      | Increment Song Step#            | User defined function | Mute/ Unmute Harmony Voices |
|   | Hold   | Repeat Decrement Step #         | Repeat Increment Step#          | User defined function | Bypass/ Unbypass            |

\* Direct buttons are programmed when the second character of the LED display is a \*, otherwise the mode is changed.

# MIDI IMPLEMENTATION

| Parameter Name         | CC# | Range / Description    |
|------------------------|-----|------------------------|
| Voice 1 Level          | 46  | 0-127                  |
| Voice 1 Voicing        | 14  | Harmony Mode Dependent |
| Voice 1 Gender         | 29  | 0-127                  |
| Voice 1 Vibrato Style  | 89  | 0-Number of Styles     |
| Voice 1 Vibrato Amount | 90  | 0-100                  |
| Voice 1 Pan            | 16  | 0-127                  |
| Voice 1 Active         | 106 | 0-63 Off, 64-127 On    |
| Voice 2 Level          | 17  | 0-127                  |
| Voice 2 Voicing        | 18  | Harmony Mode Dependent |
| Voice 2 Gender         | 19  | 0-127                  |
| Voice 2 Vibrato Style  | 61  | 0-Number of Styles     |
| Voice 2 Vibrato Amount | 62  | 0-100                  |
| Voice 2 Pan            | 20  | 0-127                  |
| Voice 2 Active         | 107 | 0-63 Off, 64-127 On    |
| Voice 3 Level          | 21  | 0-127                  |
| Voice 3 Voicing        | 22  | Harmony Mode Dependent |
| Voice 3 Gender         | 23  | 0-127                  |
| Voice 3 Vibrato Style  | 88  | 0-Number of Styles     |
| Voice 3 Vibrato Amount | 15  | 0-100                  |
| Voice 3 Pan            | 24  | 0-127                  |
| Voice 3 Active         | 108 | 0-63 Off, 64-127 On    |
| Voice 4 Level          | 25  | 0-127                  |
| Voice 4 Voicing        | 26  | Harmony Mode Dependent |
| Voice 4 Gender         | 27  | 0-127                  |
| Voice 4 Vibrato Style  | 3   | 0-Number of Styles     |
| Voice 4 Vibrato Amount | 105 | 0-100                  |
| Voice 4 Pan            | 28  | 0-127                  |
| Voice 4 Active         | 109 | 0-63 Off, 64-127 On    |
| Harmony Root           | 30  | 0-11                   |
| Harmony Type           | 31  | Harmony Mode Dependent |
| Harmony Level          | 12  | 0-127                  |
| Harmony Smooth         | 116 | 0-127                  |
| Harmony Style Amount   | 41  | 0-127                  |
| Harmony Portamento     | 84  | 0-127                  |
| Harmony Notes Attack   | 73  | 0-127                  |
| Harmony Notes Release  | 72  | 0-127                  |
| Harmony Latch          | 35  | 0-63 Off, 64-127 On    |
| Harmony Bypass         | 110 | 0-63 Off, 64-127 On    |
| Thickening Bypass      | 111 | 0-127                  |

# MIDI IMPLEMENTATION

| Parameter Name         | CC# | Range / Description                                       |
|------------------------|-----|---|
| Fx Level               | 91  | 0-127   |
| Fx Rev:Delay Mix       | 51  | 0-127   |
| Fx Lead2Reverb Send    | 52  | 0-127   |
| Fx Harmony2Reverb Send | 53  | 0-127   |
| Fx Lead2Delay Send     | 55  | 0-127   |
| Fx Harmony2Delay Send  | 56  | 0-127   |
| Fx Delay2Reverb Send   | 58  | 0-127   |
| Fx Reverb Type         | 59  | 0-13  |
| Fx Delay Type          | 63  | 0-2   |
| Fx Delay Feedback      | 45  | 0-127   |
| Fx Bypass              | 112 | 0-63 Off, 64-127 On                                       |
| Correction Scale Root  | 47  | 0-11  |
| Correction Scale Type  | 48  | 0-5   |
| Correction Window      | 49  | 0-127   |
| Correction Attack      | 54  | 0-127   |
| Correction Amount      | 57  | 0-127   |
| Correction Scale LSB   | 117 | *Special  |
| Correction Scale MSB   | 118 | *Special  |
| Correction Bypass      | 113 | 0-63 Off, 64-127 On                                       |
| Setup Dry Level        | 13  | 0-127   |
| Setup Lead Pan         | 10  | 0-127   |
| Setup Dynamics         | 60  | 0-3   |
| Setup EQ Routing       | 44  | 0-3   |
| Setup Low Shelf Freq   | 80  | 0-127   |
| Setup Low Cut Boost    | 81  | 0-127   |
| Setup High Shelf Freq  | 82  | 0-127   |
| Setup High Cut Boost   | 83  | 0-127   |
| Setup Mid Freq         | 50  | 0-127   |
| Setup Mid Boost        | 85  | 0-127   |
| Setup EQ Q             | 86  | 0-127   |
| Setup Output Level     | 87  | 0-127   |
| Sustain Pedal          | 64  | 0-63 Off, 64-127 On                                       |
|                        |     | Affects performance in Notes and Chord Mode presets only. |

*Note: Wherever applicable, the entire CC range is mapped to a given parameter.*

# MIDI IMPLEMENTATION

| Parameter Name          | CC# | Range / Description       |
|-------------------------|-----|---------------------------|
| Instrument Pan          | 102 | 0-127                     |
| Instrument Level        | 103 | 0-127                     |
| Bypass All              | 114 | 0-63 Off, 64-127 On       |
| Harmony Hold CC Control | 119 | 0-63 Off, 64-127 On       |
| Global Vibrato          | 1   | 0-127                     |
| Song Step Forward       | 115 | >63, Song Steps Forward"  |
| Song Step Backward      | 9   | >63, Song Steps Backward" |

## \*Special CC's (same for both the Advanced and GM-Basic CC maps)

|                              |           |                       |                           |
|------------------------------|-----------|-----------------------|---------------------------|
| Pitch Correction Scale Notes | 118       | MSB                   | 0nnpqrsB (Binary Pattern) |
|                              |           | nn                    | reserved                  |
|                              |           | o=1                   | C note on                 |
|                              |           | p=1                   | C#/Db note on             |
|                              |           | q=1                   | D note on                 |
|                              |           | r=1                   | D#/Eb note on             |
|                              |           | s=1                   | E note on                 |
|                              | 117       | LSB                   | 0tuvwxzB                  |
|                              |           | t=1                   | F note on                 |
|                              |           | u=1                   | F#/Gb note on             |
|                              |           | v=1                   | G note on                 |
|                              |           | w=1                   | G#/Ab note on             |
|                              |           | x=1                   | A note on                 |
|                              |           | y=1                   | A#/Bb note on             |
| z=1                          | B note on |                       |                           |
|                              | o...z=0   | notes off use 0 value |                           |

### Example Custom Scale Message:

Intended scale: C, E, G, B based on a C root. This scale may be transposed by changing the scale root.

Message: CC#118, 00010001 (converts to 17 decimal), CC#117, 00010001 (17 decimal)

MIDI Program Change messages result in a Song Number change while in **Song mode**. In any other mode, MIDI Program Change messages result in a Preset Number change.

**Note:** To capture the desired correction scale you can change the correction scale from the front panel and record the MIDI out.

### **Other MIDI messages:**

Program Change: Received/Transmitted. In Song mode only received  
- changes Song number.

Pitch Bend: Received. Controls Pitch or Gender, assignable in preset.

Note On/Off: Received.

# TECHNICAL SPECIFICATIONS

## Digital Inputs and Outputs

Connectors: RCA Phono (S/PDIF)  
Formats: S/PDIF (24 bit), EIAJ CP-340, IEC 958  
Sample Rates: 44.1 kHz, 48 kHz  
Frequency Response DIO: DC to 22/23.9 kHz  $\pm$  0.01 dB @ 44.1/48 kHz

## Analog Inputs

Connectors, balanced: Mic.: XLR, Line: 1/4" phone jack  
Impedance: Balanced/Unbalanced Mic.: 3.6/1.8 kOhm, Line: 21/13 kOhm  
Line Input Level @ 0 dBFS: 24 dBu to 0 dBu  
Line Sensitivity @ 12 dB headroom: 12 dBu to -12 dBu  
Instrument Input Level @ 0 dBFS: 18 dBu to -12 dBu  
Instrument Sensitivity @ 12 dB headroom: 6 dBu to -24 dBu  
Mic. Input Level @ 0 dBFS: Pad Off/On -13 dBu/7 dBu to -51 dBu/-31 dBu  
Mic. Sensitivity @ 12 dB headroom: Pad Off/On -25 dBu/-5 dBu to -63 dBu/-43 dBu  
Line, Mic. @ Min gain, Dynamic Range: > 92 dB, 20 Hz - 20 kHz  
EIN @ Max. mic amp. gain, Rg = 200 Ohm: 126 dBu  
THD: < -100 dB (0.001 %) @ 1 kHz  
Line Frequency Response: +0/-0.1 dB, 20 Hz to 20 kHz  
Mic. Frequency Response, max gain: -1.5 dB @ 40 Hz, +0/-0.1 dB (200 Hz to 20 kHz)  
Crosstalk: < -85 dB, 20 Hz to 20 kHz  
A to D Conversion: 24 bit, 128 x oversampling bitstream  
A to D Delay: 0.65/0.70 ms @ S.R. = 48/44.1 kHz

## Analog Outputs

D to A Conversion: 24 bit, 128 x oversampling bitstream  
D to A Delay: 0.63/0.68 ms @ S.R. = 48/44.1 kHz  
Connectors, balanced: 1/4" phone jack  
Output Impedance: 40 Ohm  
Max. Output Level: Balanced/Unbalanced 20 dBu/14 dBu, R-load = 1200 Ohm  
Output Range: 20 dBu / 14 dBu / 8 dBu / 2 dBu  
Dynamic Range: > 104 dB, 20 Hz to 20 kHz  
THD: < -98 dB (0.0013 %) @ 1 kHz  
Frequency Response: +0/-0.3 dB, 20 Hz to 20 kHz  
Crosstalk: < -100 dB, 20 Hz to 20 kHz

## EMC

Complies with: EN 55103-1 and EN 55103-2  
FCC part 15, Class B, CISPR 22, Class B

## Safety

Certified to: IEC 65, EN 60065, UL6500 and CSA E60065  
CSA FILE #LR108093

## Environment

Operating Temperature: 32° F to 122° F (0° C to 50° C)  
Storage Temperature: -22° F to 167° F (-30° C to 70° C)  
Humidity: Max. 90 % non-condensing

## Control Interface

MIDI: In/Out/Thru: 5 Pin DIN  
Pedal: 1/4" phone jack

## Supplementary

Display: 4 character LED, 16x 2 character LCD  
Dimensions: 11.1" x 10.25" x 3.5" (282 x 260 x 89 mm)  
Weight: 5.9 lb. (2.7 kg)  
Mains Voltage: 100 to 240 VAC, 50 to 60 Hz (auto-select)  
Power Consumption: <15 W  
Warranty Parts and labor: 1 year

**Due to continuous development these specifications are subject to change without notice.**